

2024

Pure +
Forms

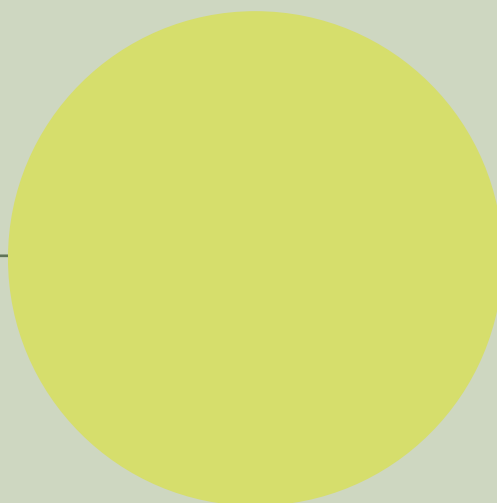

FLAVIKER

2024

Pure +
Forms

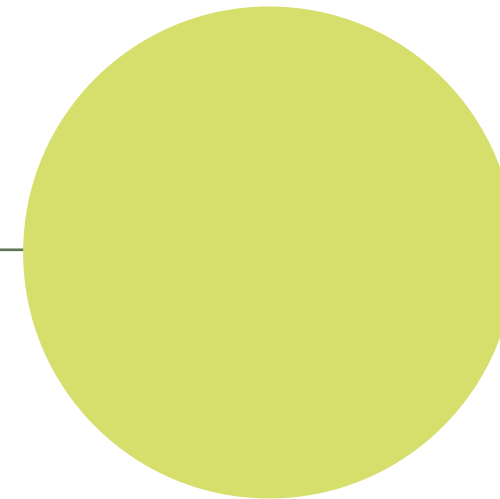

FLAVIKER

Index

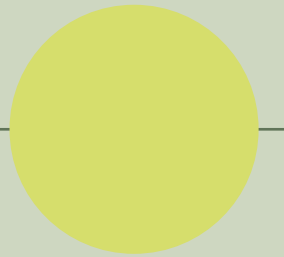

Projects

Marble	Supreme Memories Supreme Treasure Supreme Evo Supreme Classic Navona
Stone	Double Rockin' Blue Savoy Re_Tour Nordik Stone
Wood	Four Seasons Nordik Wood Cozy Flaviker-Dakota Zen
Metal	Rebel
Concrete	Hyper Backstage

Decor & Wall

	Art Walls Flow Chrome
--	-----------------------------

Outdoor

X20 - 20 mm	Supreme Memories Double Rockin' Hyper Blue Savoy Still No_w Rebel Nordik Stone Re_Tour Navona Four Seasons Nordik Wood Cozy Flaviker-Dakota
X30 - 30 mm	Backstage Nordik Stone Rebel Navona Flaviker-Dakota

Technical Information



FLAVIKER
 si conferma protagonista
 dell'industria ceramica
 Made in Italy, sul fronte
 dell'innovazione e
 della ricerca prodotto.

Le nuove tecnologie messe a punto nei nostri laboratori sono in grado di produrre superfici dalle straordinarie performance e dall'indiscutibile appeal, per disegnare spazi e architetture con un occhio sempre attento alla qualità e al design.

FLAVIKER continues to be a leading player in the Italian ceramic tile industry in terms of innovation and product research.

The new technologies developed in our laboratories create surfaces with extraordinary levels of technical performance and aesthetic appeal, ideal for buildings and architectural spaces that stand out for their attention to quality and design.



Index

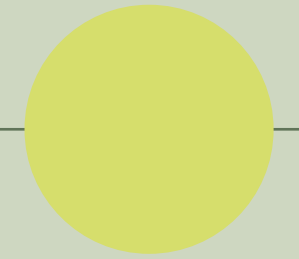

Projects

Marble	Supreme Memories Supreme Treasure Supreme Evo Supreme Classic Navona
Stone	Double Rockin' Blue Savoy Re_Tour Nordik Stone
Wood	Four Seasons Nordik Wood Cozy Flaviker-Dakota Zen
Metal	Rebel
Concrete	Hyper Backstage

Decor & Wall

	Art Walls Flow Chrome
--	-----------------------------

Outdoor

X20 - 20 mm	Supreme Memories Double Rockin' Hyper Blue Savoy Still No_w Rebel Nordik Stone Re_Tour Navona Four Seasons Nordik Wood Cozy Flaviker-Dakota
X30 - 30 mm	Backstage Nordik Stone Rebel Navona Flaviker-Dakota

Technical Information



The value of our identity



Dietro alla forza del brand FLAVIKER c'è la storia di un gruppo industriale multinazionale, leader tra i player del settore ceramico Italiano. ABK GROUP vanta oggi una capacità produttiva di 13 milioni di mq al servizio di

diversi marchi commerciali, con una gamma d'eccellenza, diversificata per soddisfare ogni necessità in fatto di pavimenti e rivestimenti, compresi i prodotti outdoor e le grandi lastre.

The strength of the FLAVIKER brand is rooted in the history of a multinational industrial group that is now one of the leading players in the Italian ceramic industry. Today, ABK GROUP has a production capacity of 13 million

square metres divided up into a number of brands. It has an outstanding product portfolio suited to all floor and wall covering requirements, including outdoor products and large slabs.

Our numbers



More than **13 mln sqm**
Production capacity



More than **7,0 mln sqm**
Warehouse capacity

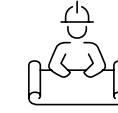

More than **800**
Employees

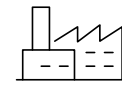

More than **200.000 sqm**
Building Area



120
Countries Served



More than **7.000**
Worldwide Customers

Our locations

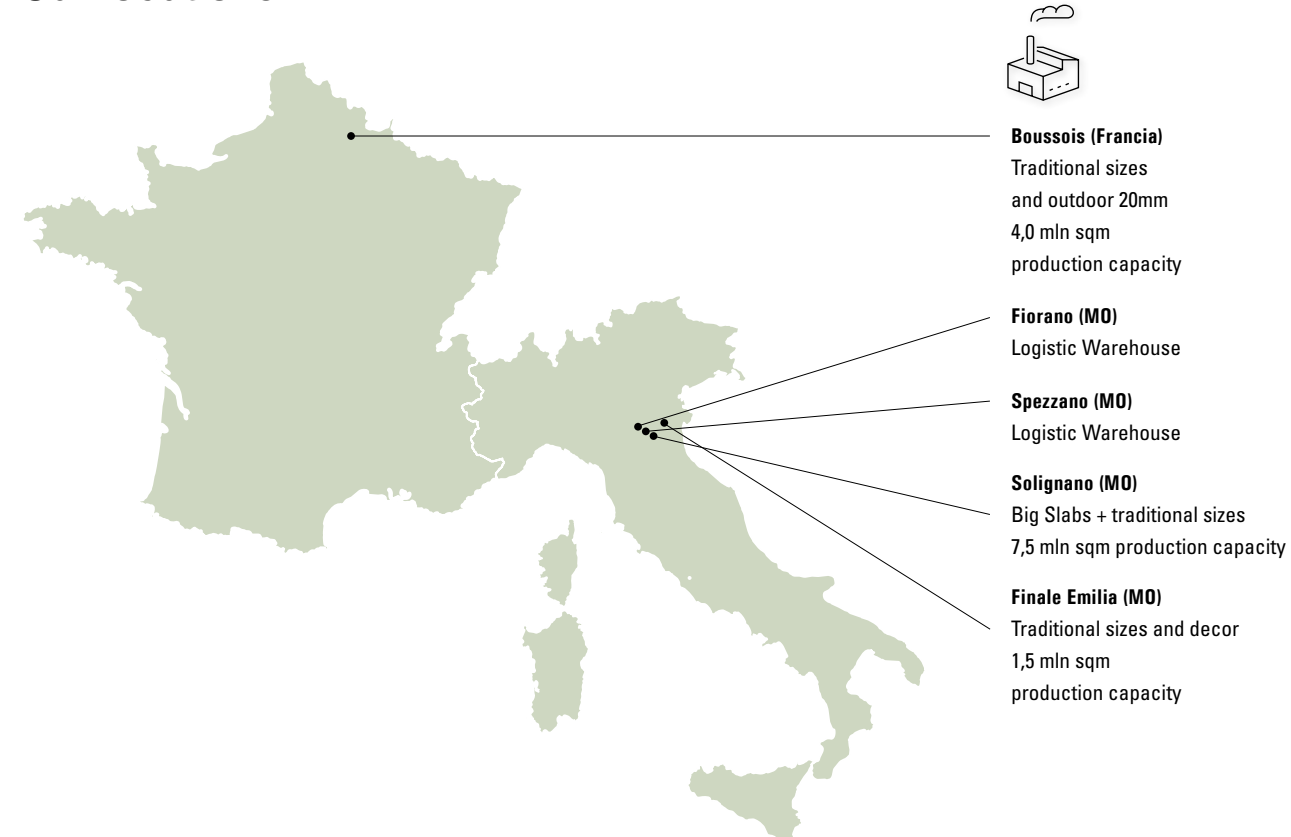

Index

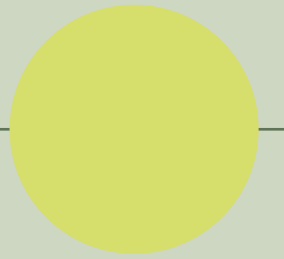

Projects

Marble	Supreme Memories Supreme Treasure Supreme Evo Supreme Classic Navona
Stone	Double Rockin' Blue Savoy Re_Tour Nordik Stone
Wood	Four Seasons Nordik Wood Cozy Flaviker-Dakota Zen
Metal	Rebel
Concrete	Hyper Backstage

Decor & Wall

	Art Walls Flow Chrome
--	-----------------------------

Outdoor

X20 - 20 mm	Supreme Memories Double Rockin' Hyper Blue Savoy Still No_w Rebel Nordik Stone Re_Tour Navona Four Seasons Nordik Wood Cozy Flaviker-Dakota
X30 - 30 mm	Backstage Nordik Stone Rebel Navona Flaviker-Dakota

Technical Information



Exclusive Technology

3Dtech

La tecnologia 3D Tech consente di applicare differenti materie ceramiche, anche a spessore, in perfetta corrispondenza con la grafica sottostante, realizzata in digitale ad

altissima definizione. Un processo produttivo rivoluzionario, che combina la matericità con l'estetica del prodotto, fino ad ottenere superfici dallo straordinario valore sensoriale.

The new 3D Tech technology allows thick layers of various ceramic materials to be applied in perfect alignment with the underlying graphic designs, which are created

digitally with extremely high definition. This revolutionary production process combines material and aesthetic effects to create surfaces with extraordinary sensorial appeal.

SOFT 3D

La tecnologia SOFT 3D consente di realizzare lastre dalla finitura extra morbida arricchite da effetti di bassorilievo che ne esaltano la naturalezza. La differente densità delle materie

utilizzate in superficie, nelle zone selezionate, ricrea chimicamente le profondità, che si sovrappongono in maniera esatta alla grafica digitale ad alta risoluzione.

The SOFT 3D technology allows to create slabs with an extra smooth finish, enriched with bas-relief effects that enhance the naturalness of the surface. The different density of the

raw materials applied in the selected areas, chemically recreates the depths that exactly match the high-resolution digital graphic.



Index



Projects

Marble	Supreme Memories Supreme Treasure Supreme Evo Supreme Classic Navona
Stone	Double Rockin' Blue Savoy Re_Tour Nordik Stone
Wood	Four Seasons Nordik Wood Cozy Flaviker-Dakota Zen
Metal	Rebel
Concrete	Hyper Backstage

Decor & Wall

	Art Walls Flow Chrome
--	-----------------------------

Outdoor

X20 - 20 mm	Supreme Memories Double Rockin' Hyper Blue Savoy Still No_w Rebel Nordik Stone Re_Tour Navona Four Seasons Nordik Wood Cozy Flaviker-Dakota
X30 - 30 mm	Backstage Nordik Stone Rebel Navona Flaviker-Dakota

Technical Information

FULLBODY3D

Grazie ai più evoluti sistemi di miscelazione e pressatura degli impasti ceramici, FLAVIKER è in grado di ricreare la complessa struttura dei materiali lapidei. L'esclusiva tecnologia FULLBODY 3D permette di ottenere ciò che la natura ha creato nei millenni, riproducendo

l'estetica delle pietre sia in superficie che nel corpo della lastra. La continuità tra massa, superficie e bordo delle lastre è garantita anche dopo le operazioni di taglio, foratura e rifinitura necessarie a ottenere il prodotto finito.

Flaviker uses the most advanced ceramic body mixing and pressing systems to recreate the complex structure of stone. Emulating the processes that occur in nature over millions of years, the unique FULLBODY 3D technology

reproduces the aesthetics of stone both on the surface and within the body of the slab. This ensures seamless continuity between the body, the surface and the edge of the slabs even after cutting, drilling and finishing operations.



P. tech

La tecnologia P.TECH migliora la resistenza allo scivolamento, pur mantenendo una piacevole sensazione al tatto. P.TECH è il risultato di un innovativo processo produttivo che coniuga la selezione delle materie prime con le fasi di pressatura, cottura e lavorazione a fine linea.

I prodotti P.TECH, R10 ed R11, pur raggiungendo i più elevati coefficienti di attrito, si puliscono facilmente, per questo possono essere utilizzati nei progetti wellness e outdoor, anche in aree pubbliche o commerciali.

The unique P.TECH technology improves slip resistance while maintaining a pleasant tactile sensation. P.TECH is the result of an innovative production process that combines a meticulous selection of raw materials with the pressing, firing and end-of-line processing stages.

Despite their high coefficient of friction, R10 and R11 P.TECH products are easy to clean, making them ideal not only for use on indoor floors but also in wellness and outdoor spaces in public or commercial areas.



Index



Projects

Marble	Supreme Memories Supreme Treasure Supreme Evo Supreme Classic Navona
Stone	Double Rockin' Blue Savoy Re_Tour Nordik Stone
Wood	Four Seasons Nordik Wood Cozy Flaviker-Dakota Zen
Metal	Rebel
Concrete	Hyper Backstage

Decor & Wall

	Art Walls Flow Chrome
--	-----------------------------

Outdoor

X20 - 20 mm	Supreme Memories Double Rockin' Hyper Blue Savoy Still No_w Rebel Nordik Stone Re_Tour Navona Four Seasons Nordik Wood Cozy Flaviker-Dakota
X30 - 30 mm	Backstage Nordik Stone Rebel Navona Flaviker-Dakota

Technical Information



Alphabetical index

Indice Alfabetico

Porcelain Tiles

Backstage	200
Blue Savoy	106
Cozy	156
Flaviker-Dakota	164
Double	80
Four Seasons	138
Hyper	190
Navona	68
Nordik Stone	128
Nordik Wood	148
Re_tour	118
Rebel	178
Rockin'	94
Supreme Classic	64
Supreme Evo	52
Supreme Memories	24
Supreme Treasure	38
Zen	172

Decor & Wall

Art Walls	208
Chrome	226
Flow	222

Outdoor

X20 - 20 mm	232
X30 - 30 mm	248

Technical Info

252

+ Index by sizes Indice per formato

160x320

Blue Savoy	106
Chrome	226
Hyper	190
Navona	68
Rebel	178
Supreme Evo	52

120x280

Blue Savoy	106
Chrome	226
Double	80
Four Seasons	138
Hyper	190
Navona	68
Re_tour	118
Rebel	178
Rockin'	94
Supreme Evo	52
Supreme Memories	24
Supreme Treasure	38

26x200

Cozy	156
Four Seasons	138
Nordik Wood	148

40x170

Flaviker-Dakota	164
-----------------	-----

20x170

Flaviker-Dakota	164
-----------------	-----

80x160

Double	80
--------	----

120x120

Blue Savoy	106
Chrome	226
Double	80
Hyper	190
Navona	68
Nordik Stone	128
Re_tour	118
Rebel	178
Rockin'	94
Supreme Evo	52
Supreme Memories	24
Supreme Treasure	38

60x120

Backstage	200
Blue Savoy	106
Chrome	226
Double	80
Hyper	190
Navona	68
Nordik Stone	128
Re_tour	118
Rebel	178
Rockin'	94
Supreme Classic	64
Supreme Evo	52
Supreme Memories	24
Supreme Treasure	38

40x120

Supreme Treasure	38
------------------	----

30x120

Flaviker-Dakota	164
Four Seasons	138

20x120

Cozy	156
Flaviker-Dakota	164
Four Seasons	138
Nordik Wood	148
Rockin'	94
Zen	172

5x120

Four Seasons	138
--------------	-----

90x90

Nordik Stone	128
Re_tour	118

80x80

Backstage	200
Double	80
Hyper	190
Navona	68
Rebel	178

40x80

Backstage	200
-----------	-----

20x80

Flaviker-Dakota	164
-----------------	-----

60x60

Backstage	200
Blue Savoy	106
Hyper	190
Navona	68
Nordik Stone	128
Nordik Wood	148
Re_tour	118
Rebel	178
Rockin'	94

30x60

Blue Savoy	106
Hyper	190
Navona	68
Rebel	178

10x60

Blue Savoy	106
Four Seasons	138
Nordik Wood	148

20x40

Backstage	200
-----------	-----

Index



Projects

Marble	Supreme Memories Supreme Treasure Supreme Evo Supreme Classic Navona
Stone	Double Rockin' Blue Savoy Re_Tour Nordik Stone
Wood	Four Seasons Nordik Wood Cozy Flaviker-Dakota Zen
Metal	Rebel
Concrete	Hyper Backstage

Decor & Wall

Art Walls Flow Chrome

Outdoor

X20 - 20 mm	Supreme Memories Double Rockin' Hyper Blue Savoy Still No_w Rebel Nordik Stone Re_Tour Navona Four Seasons Nordik Wood Cozy Flaviker-Dakota
X30 - 30 mm	Backstage Nordik Stone Rebel Navona Flaviker-Dakota

Technical Information

Gres
Porcellanato
Porcelain
Tiles

Principali Formati
Disponibili
Main Sizes
Available

superfici
surfaces



Double pag. 80		Rockin' pag. 94	Blue Savoy pag. 106	Re_tour pag. 118	Nordik Stone pag. 128
120x280 120x120 60x120 80x160 80x80		120x280 120x120 60x120 20x120 60x60	160x320 120x280 120x120 60x120 60x60 30x60 10x60	120x280 120x120 60x120 90x90 60x90 60x60	120x120 60x120 90x90 60x60
NAT / LUX 3D		NAT R11	NAT / LUX R11	NAT R11	NAT R11
			GRAPHITE		
		LAVA		MUD	BLACK
LINEAR GREY PLAIN GREY		GREY	BLUE	FOG	GREY
LINEAR WHITE PLAIN WHITE			GREY		ASH
		ICE			
LINEAR BEIGE PLAIN BEIGE			MOON	IVORY	
		DESERT			SAND
				ROPE	
LINEAR MINT PLAIN MINT					
Stone					

Navona pag. 68	Supreme Memories pag. 24	Supreme Treasure pag. 38	Supreme Evo pag. 52	Supreme Classic pag. 64
160x320 120x280 120x120 60x120 80x80 60x60 30x60	120x280 120x120 60x120 7,5x40,7	120x280 120x120 60x120	160x320 120x280 120x120 60x120 80x80	60x120
NAT R11	NAT / LUX 3D SOFT / SOFT 3D / ANT. 3D	NAT / LUX SOFT / SOFT 3D ANT. 3D	NAT / LUX SOFT / ANT. 3D	ANT LUX
	DARK STONE		CLASSIC MARQUINIA	NOIR LAURENT
	BRECCIA IMPERIALE			
	GREY SOAPSTONE		GREY AMANI	
GREY VEIN GREY CROSS	QUARZITE LUNA	GREYLAC PLATINUM	INVISIBLE SELECT	
	BIANCO VAGLI	LASA SAPPHIRE	STATUARIO SUPERIOR	PURE STATUARIO
				ROYAL STATUARIO
BONE VEIN BONE CROSS	PULPIS IVORY	CRISTALLO AMBER	ANTIQUE WHITE	CALACATTA EXTRA
				GOLDEN CALACATTA
HONEY VEIN HONEY CROSS	ROSA PERLINO	CORCHIA GOLD		ONYX PRESTIGE
			LUMINOUS EVEROSE	
			CALACATTA EMERALD	
Marble				

Index

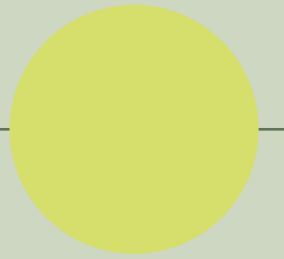

Projects

Marble	Supreme Memories Supreme Treasure Supreme Evo Supreme Classic Navona
Stone	Double Rockin' Blue Savoy Re_Tour Nordik Stone
Wood	Four Seasons Nordik Wood Cozy Flaviker-Dakota Zen
Metal	Rebel
Concrete	Hyper Backstage

Decor & Wall

	Art Walls Flow Chrome
--	-----------------------------

Outdoor

X20 - 20 mm	Supreme Memories Double Rockin' Hyper Blue Savoy Still No_w Rebel Nordik Stone Re_Tour Navona Four Seasons Nordik Wood Cozy Flaviker-Dakota
X30 - 30 mm	Backstage Nordik Stone Rebel Navona Flaviker-Dakota

Technical Information

Gres
Porcellanato
Porcelain
Tiles

Principali Formati
Disponibili
Main Sizes
Available

superfici
surfaces



Rebel
pag. 178

160x320
120x280
120x120
60x120
80x80
60x60
30x60

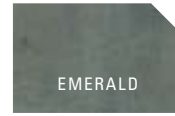
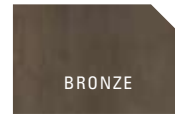
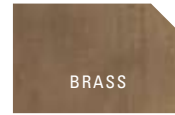
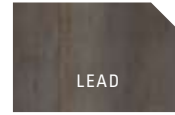

Metal

Hyper
pag. 190

160x320
120x280
120x120
60x120
60x60
30x60

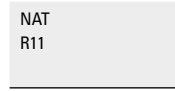

Concrete

Backstage
pag. 200

60x120
80x80
40x80
60x60
20x40

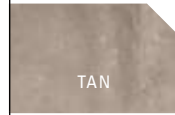
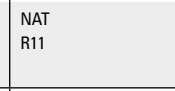

Concrete

Four Seasons
pag. 138

120x280
26x200
30x120
20x120
5x120
10x60
7,5x40,7

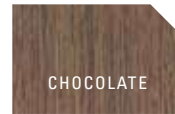
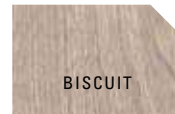
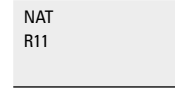

Wood

Nordik Wood
pag. 148

26x200
20x120
60x60
10x60

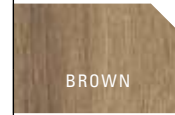

Wood

Cozy
pag. 156

26x200
20x120

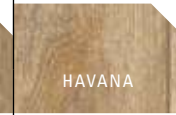

Wood

Flaviker-Dakota
pag. 164

40x170
20x170
30x120
20x120
20x80

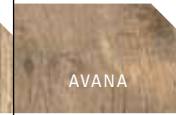

Wood

Zen
pag. 172

20x120

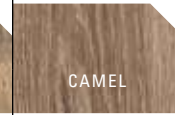
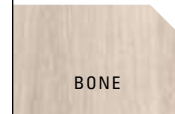
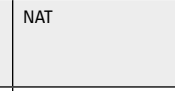

Wood

Index



Projects

Marble	Supreme Memories Supreme Treasure Supreme Evo Supreme Classic Navona
Stone	Double Rockin' Blue Savoy Re_Tour Nordik Stone
Wood	Four Seasons Nordik Wood Cozy Flaviker-Dakota Zen
Metal	Rebel
Concrete	Hyper Backstage

Decor & Wall

	Art Walls Flow Chrome
--	-----------------------------

Outdoor

X20 - 20 mm	Supreme Memories Double Rockin' Hyper Blue Savoy Still No_w Rebel Nordik Stone Re_Tour Navona Four Seasons Nordik Wood Cozy Flaviker-Dakota
X30 - 30 mm	Backstage Nordik Stone Rebel Navona Flaviker-Dakota

Technical Information



No-Slip Surface

La versatilità delle superfici Flaviker si afferma anche dove si elevano i parametri di anti-scivolosità. Non solo per le aree outdoor, ma anche nelle zone wellness, per bordi piscina sia interni che esterni, la gamma offre numerose soluzioni in grado di rispondere ai requisiti tecnici imposti dalle norme vigenti. Gli articoli in finitura

antiscivolo riproducono tutti gli effetti materici più rappresentativi dei prodotti "indoor", per creare, dove richiesto, una perfetta continuità con gli spazi coperti, sia a spessore tradizionale che a spessore maggiorato, tenendo conto di ogni esigenza e dei diversi sistemi di posa.

The versatility of Flaviker surfaces is also evident in their anti-slip properties. Suitable for outdoor spaces and for interior and exterior wellness areas and swimming pools, the range includes numerous solutions that meet the latest technical and performance standards. The non-slip surfaces are available with the

same material effects as the most widely used indoor products in both conventional and extra-large thicknesses. This creates a sense of continuity between interior and exterior spaces while catering for all needs and installation systems.



Index

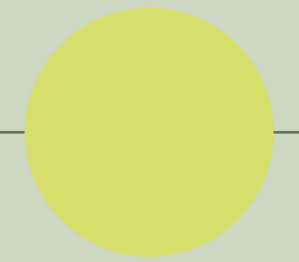

Projects

Marble	Supreme Memories Supreme Treasure Supreme Evo Supreme Classic Navona
Stone	Double Rockin' Blue Savoy Re_Tour Nordik Stone
Wood	Four Seasons Nordik Wood Cozy Flaviker-Dakota Zen
Metal	Rebel
Concrete	Hyper Backstage

Decor & Wall

	Art Walls Flow Chrome
--	-----------------------------

Outdoor

X20 - 20 mm	Supreme Memories Double Rockin' Hyper Blue Savoy Still No_w Rebel Nordik Stone Re_Tour Navona Four Seasons Nordik Wood Cozy Flaviker-Dakota
X30 - 30 mm	Backstage Nordik Stone Rebel Navona Flaviker-Dakota

Technical Information

Wall & Floor Projects

Progetti per rivestimento e pavimento

Porcelain tiles
Gres porcellanato

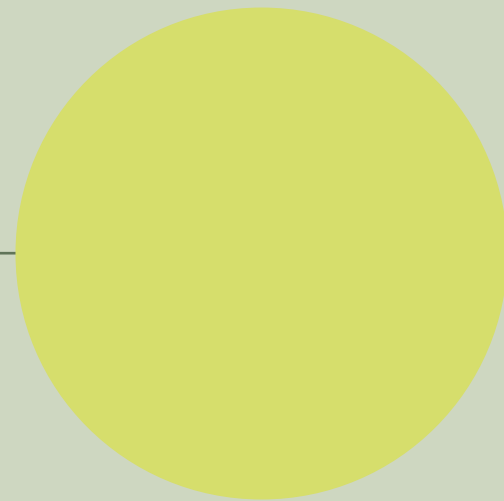

Marble

Supreme Memories
Supreme Treasure
Supreme Evo
Supreme Classic
Navona

Stone

Double
Rockin'
Blue Savoy
Re_tour
Nordik Stone

Metal

Rebel

Concrete

Hyper
Backstage

Wood

Four Seasons
Nordik Wood
Cozy
Flaviker-Dakota
Zen

Index



Projects

Marble	Supreme Memories Supreme Treasure Supreme Evo Supreme Classic Navona
Stone	Double Rockin' Blue Savoy Re_Tour Nordik Stone
Wood	Four Seasons Nordik Wood Cozy Flaviker-Dakota Zen
Metal	Rebel
Concrete	Hyper Backstage

Decor & Wall

	Art Walls Flow Chrome
--	-----------------------------

Outdoor

X20 - 20 mm	Supreme Memories Double Rockin' Hyper Blue Savoy Still No_w Rebel Nordik Stone Re_Tour Navona Four Seasons Nordik Wood Cozy Flaviker-Dakota
X30 - 30 mm	Backstage Nordik Stone Rebel Navona Flaviker-Dakota

Technical Information



Supreme

Memories

Gres Porcellanato tutta massa **UGL**
Full Body Porcelain



Breccia Imperiale



Bianco Vagli



Dark Stone



Quarzite Luna



Grey Soapstone



Pulpis Ivory

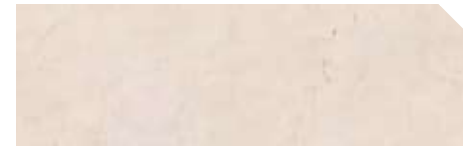

Rosa Perlino

Treasure

Gres Porcellanato tutta massa **UGL**
Full Body Porcelain

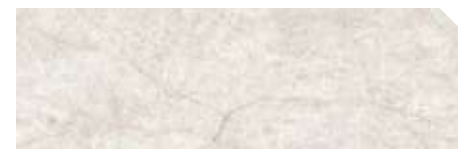

Calacatta Emerald



Corchia Gold



Greylac Platinum



Luminous Everose



Cristallo Amber



Lasa Sapphire

Evo

Gres Porcellanato tutta massa **UGL**
Full Body Porcelain



Antique White



Noir Laurent



Invisible Select



Classic Marquinia



Statuario Superior



Grey Amani



Pure Statuario



Calacatta Extra

Classic

Gres porcellanato a massa colorata
Full Body Colored Porcelain



Golden Calacatta



Onyx Prestige

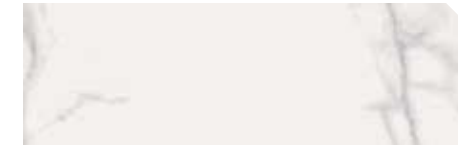

Royal Statuario

Index

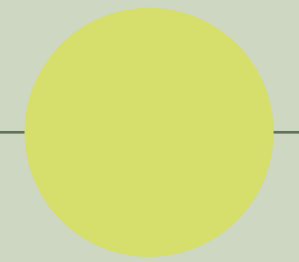

Projects

Marble	Supreme Memories Supreme Treasure Supreme Evo Supreme Classic Navona
Stone	Double Rockin' Blue Savoy Re_Tour Nordik Stone
Wood	Four Seasons Nordik Wood Cozy Flaviker-Dakota Zen
Metal	Rebel
Concrete	Hyper Backstage

Decor & Wall

	Art Walls Flow Chrome
--	-----------------------------

Outdoor

X20 - 20 mm	Supreme Memories Double Rockin' Hyper Blue Savoy Still No_w Rebel Nordik Stone Re_Tour Navona Four Seasons Nordik Wood Cozy Flaviker-Dakota
X30 - 30 mm	Backstage Nordik Stone Rebel Navona Flaviker-Dakota

Technical Information



+
Supreme Memories
Breccia Imperiale
Ant. 3D 120x120

Marble

+ Supreme Memories

Gres porcellanato tutta massa **UGL**

Full body porcelain **UGL**

P. tech **3Dtech** **SOFT 3D**

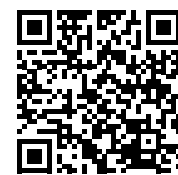

Complete Collection

Formati

Sizes

6 mm
120x280 nat/soft/soft 3D/lux 3D

8,5 mm
120x120 nat/lux/ant.3D
60x120 nat/lux/ant.3D
7,5x40,7 chevron nat

20 mm X20
60x120 R11



Breccia Imperiale



Bianco Vagli



Dark Stone



Quarzite Luna



Grey Soapstone

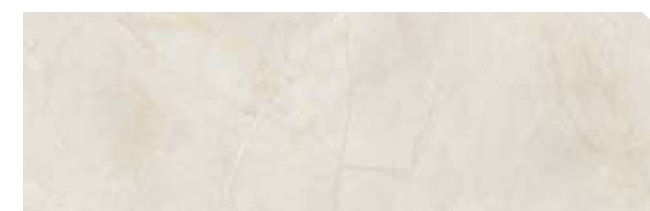

Pulpis Ivory

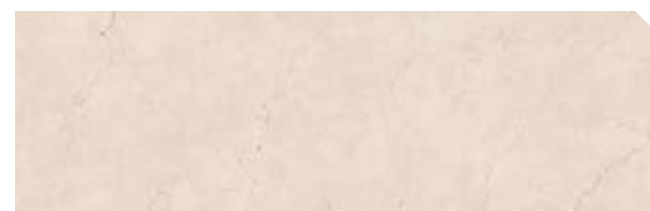

Rosa Perlino

Index

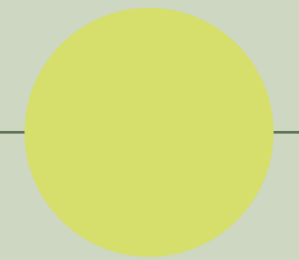

Projects

Marble	Supreme Memories Supreme Treasure Supreme Evo Supreme Classic Navona
Stone	Double Rockin' Blue Savoy Re_Tour Nordik Stone
Wood	Four Seasons Nordik Wood Cozy Flaviker-Dakota Zen
Metal	Rebel
Concrete	Hyper Backstage

Decor & Wall

Art Walls Flow Chrome

Outdoor

X20 - 20 mm	Supreme Memories Double Rockin' Hyper Blue Savoy Still No_w Rebel Nordik Stone Re_Tour Navona Four Seasons Nordik Wood Cozy Flaviker-Dakota
X30 - 30 mm	Backstage Nordik Stone Rebel Navona Flaviker-Dakota

Technical Information



Supreme Memories
Quarzite Luna
Ant. 3D 60x120

Supreme Memories
Medley Quarzite
60x120

Supreme Memories
Dark Stone
Ant. 3D 60x120

Marble

Supreme Memories



			Breccia Imperiale	Bianco Vagli	Dark Stone	Quarzite Luna	Grey Soapstone	Pulpis Ivory	Rosa Perlino
6 mm	120x280 48"x112"	LUX 3D RETT.	•	•		•		•	
	120x280 48"x112"	NAT RETT. P. TECH R10 C	•		•		•	•	•
	120x280 48"x112"	SOFT RETT.		•					
	120x280 48"x112"	SOFT 3D RETT.				•			
8,5 mm	120x120 48"x48"	LUX RETT.	•	•		•		•	
	120x120 48"x48"	NAT RETT. P. TECH R10 C	•	•	•	•	•	•	•
	120x120 48"x48"	ANT. 3D RETT. 3D TECH	•	•	•	•	•	•	•
	60x120 24"x48"	LUX RETT.	•	•		•		•	
	60x120 24"x48"	NAT RETT. P. TECH R10 C	•	•	•	•	•	•	•
	60x120 24"x48"	ANT. 3D RETT. 3D TECH	•	•	•	•	•	•	•
	7,5x40,7 3"x16" CHEVRON	NAT.	•	•		•			
20 mm	60x120 24"x48"	R11 RETT. P. TECH	•					•	

Index

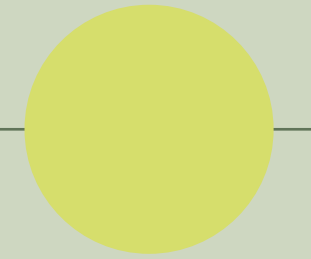

Projects

Marble	Supreme Memories Supreme Treasure Supreme Evo Supreme Classic Navona
Stone	Double Rockin' Blue Savoy Re_Tour Nordik Stone
Wood	Four Seasons Nordik Wood Cozy Flaviker-Dakota Zen
Metal	Rebel
Concrete	Hyper Backstage

Decor & Wall

	Art Walls Flow Chrome
--	-----------------------------

Outdoor

X20 - 20 mm	Supreme Memories Double Rockin' Hyper Blue Savoy Still No_w Rebel Nordik Stone Re_Tour Navona Four Seasons Nordik Wood Cozy Flaviker-Dakota
X30 - 30 mm	Backstage Nordik Stone Rebel Navona Flaviker-Dakota

Technical Information

Breccia Imperiale

6 mm					
120x280	LUX 3D R.		0014127	M. 138,50	
	NAT. R.	P.TECH R10 C	0011827	M. 101,90	
8,5 mm					
120x120	LUX R.		0012675	M. 105,90	
	NAT. R.	P.TECH R10 C	0011835	M. 80,50	
	ANT. 3D R.	3D TECH	0011854	M. 119,50	
60x120	LUX R.		0012678	M. 80,50	
	NAT. R.	P.TECH R10 C	0011841	M. 61,90	
	ANT. 3D R.	3D TECH	0011860	M. 88,50	
20 mm					
60x120	X20				
	R11 R.	P.TECH	0012571	M. 87,90	



Bianco Vagli

6 mm					
120x280	LUX 3D R.		0014876	M. 138,50	
	SOFT. R.		0011824	M. 107,50	
8,5 mm					
120x120	LUX R.		0012673	M. 105,90	
	NAT. R.	P.TECH R10 C	0011832	M. 80,50	
	ANT. 3D R.	3D TECH	0011851	M. 119,50	
60x120	LUX R.		0012676	M. 80,50	
	NAT. R.	P.TECH R10 C	0011838	M. 61,90	
	ANT. 3D R.	3D TECH	0011857	M. 88,50	



Dark Stone

6 mm					
120x280	NAT. R.	P.TECH R10 C	0012617	M. 101,90	
8,5 mm					
120x120	NAT. R.	P.TECH R10 C	0012618	M. 80,50	
	ANT. 3D R.	3D TECH	0012644	M. 119,50	
60x120	NAT. R.	P.TECH R10 C	0012619	M. 61,90	
	ANT. 3D R.	3D TECH	0012645	M. 88,50	



Quarzite Luna

6 mm					
120x280	LUX 3D R.		0014128	M. 138,50	
	SOFT 3D R.		0013316	M. 113,50	
8,5 mm					
120x120	LUX R.		0013318	M. 105,90	
	NAT. R.	P.TECH R10 C	0013305	M. 80,50	
	ANT. 3D R.	3D TECH	0013204	M. 119,50	
60x120	LUX R.		0013319	M. 80,50	
	NAT. R.	P.TECH R10 C	0013306	M. 61,90	
	ANT. 3D R.	3D TECH	0013293	M. 88,50	



Index

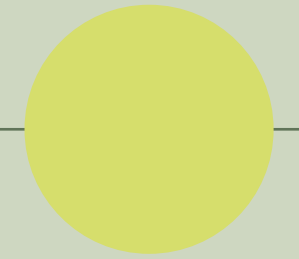

Projects

Marble	Supreme Memories
	Supreme Treasure
	Supreme Evo
	Supreme Classic
	Navona
Stone	Double Rockin'
	Blue Savoy
	Re_Tour
	Nordik Stone
Wood	Four Seasons
	Nordik Wood
	Cozy
	Flaviker-Dakota
	Zen
Metal	Rebel
Concrete	Hyper
	Backstage

Decor & Wall

	Art Walls
	Flow
	Chrome

Outdoor

X20 - 20 mm	Supreme Memories
	Double
	Rockin'
	Hyper
	Blue Savoy
	Still No_w
	Rebel
	Nordik Stone
	Re_Tour
	Navona
	Four Seasons
	Nordik Wood
	Cozy
	Flaviker-Dakota
X30 - 30 mm	Backstage
	Nordik Stone
	Rebel
	Navona
	Flaviker-Dakota

Technical Information

+ Supreme Memories

Grey Soapstone

6 mm				
120x280	NAT. R.	P.TECH R10 C	0011825	M 101,90

8,5 mm				
120x120	NAT. R.	P.TECH R10 C	0011833	M 80,50
	ANT. 3D R.	3D TECH	0011852	M 119,50
60x120	NAT. R.	P.TECH R10 C	0011839	M 61,90
	ANT. 3D R.	3D TECH	0011858	M 88,50



Pulpis Ivory

6 mm				
120x280	LUX 3D R.		0014126	M 138,50
	NAT. R.	P.TECH R10 C	0011826	M 101,90

8,5 mm				
120x120	LUX R.		0012674	M 105,90
	NAT. R.	P.TECH R10 C	0011834	M 80,50
	ANT. 3D R.	3D TECH	0011853	M 119,50
60x120	LUX R.		0012677	M 80,50
	NAT. R.	P.TECH R10 C	0011840	M 61,90
	ANT. 3D R.	3D TECH	0011859	M 88,50

20 mm				
60x120	X20			
	R11 R.	P.TECH	0011821	M 87,90



Rosa Perlino

6 mm				
120x280	NAT. R.	P.TECH R10 C	0011823	M 101,90

8,5 mm				
120x120	NAT. R.	P.TECH R10 C	0011831	M 80,50
	ANT. 3D R.	3D TECH	0011850	M 119,50
60x120	NAT. R.	P.TECH R10 C	0011837	M 61,90
	ANT. 3D R.	3D TECH	0011856	M 88,50



Marble

Chevron

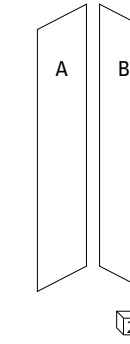

Breccia Imperiale

8,5 mm	7,5x40,7	CHEVRON NAT	0012692	M 66,90
--------	----------	-------------	---------	---------

Bianco Vagli

8,5 mm	7,5x40,7	CHEVRON NAT	0012691	M 66,90
--------	----------	-------------	---------	---------

Quarzite Luna

8,5 mm	7,5x40,7	CHEVRON NAT	0013324	M 66,90
--------	----------	-------------	---------	---------

Index

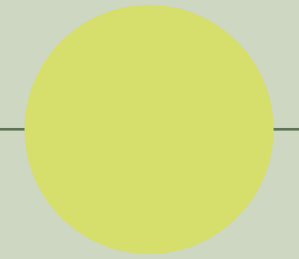

Projects

Marble	Supreme Memories
	Supreme Treasure
	Supreme Evo
	Supreme Classic
	Navona
Stone	Double
	Rockin'
	Blue Savoy
	Re_Tour
	Nordik Stone
Wood	Four Seasons
	Nordik Wood
	Cozy
	Flaviker-Dakota
	Zen
Metal	Rebel
Concrete	Hyper
	Backstage

Decor & Wall

	Art Walls
	Flow
	Chrome

Outdoor

X20 - 20 mm	Supreme Memories
	Double
	Rockin'
	Hyper
	Blue Savoy
	Still No_w
	Rebel
	Nordik Stone
	Re_Tour
	Navona
	Four Seasons
	Nordik Wood
	Cozy
	Flaviker-Dakota
X30 - 30 mm	Backstage
	Nordik Stone
	Rebel
	Navona
	Flaviker-Dakota

Technical Information

3D tech



60x120
0013289
MEDLEY BRECCIA NAT. RETT.
M 84,50 8,5 mm



60x120
0013290
MEDLEY QUARZITE NAT. RETT.
M 84,50 8,5 mm



60x120
0013288
MEDLEY PULPIS NAT. RETT.
M 84,50 8,5 mm

Articolo composto da pattern grafici diversi che non prevedono agganci tra loro e miscelati in modo casuale in fase di inscatolamento. Non si garantisce pertanto la presenza costante di tutti i soggetti all'interno delle confezioni. / This article comes in several different versions with unconnected patterns that are mixed randomly at the time of packaging. There is therefore no guarantee that all patterns will be present in any individual box.

Fuga consigliata 1/2 mm. / 1/2mm joint suggested.



+
Medley
Pulpis
60x120

+
Breccia Imperiale
Soft 12mm
MATERIA

Index



Projects

Marble	Supreme Memories Supreme Treasure Supreme Evo Supreme Classic Navona
Stone	Double Rockin' Blue Savoy Re_Tour Nordik Stone
Wood	Four Seasons Nordik Wood Cozy Flaviker-Dakota Zen
Metal	Rebel
Concrete	Hyper Backstage

Decor & Wall

Art Walls Flow Chrome

Outdoor

X20 - 20 mm	Supreme Memories Double Rockin' Hyper Blue Savoy Still No_w Rebel Nordik Stone Re_Tour Navona Four Seasons Nordik Wood Cozy Flaviker-Dakota
X30 - 30 mm	Backstage Nordik Stone Rebel Navona Flaviker-Dakota

Technical Information

MATERIA.

Disponibile anche Available also		Breccia Imperiale	Bianco Vagli	Dark Stone	Quarzite Luna	Grey Soapstone	Pulpis Ivory	Rosa Perlino
			FULLVEIN3D			FULLBODY3D		
	LUX	0011912	SLAB A LUX 0011911 SLAB B LUX 0011915	-	SLAB A LUX 0013325 SLAB B LUX 0013326	-	0011913	-
	SOFT	0011919	SLAB A SOFT 0011918 SLAB B SOFT 0011923	-	-	-	-	-
12 mm 163,5x323	SOFT 3D	-	-	-	SLAB A SOFT 3D 0013327 SLAB B SOFT 3D 0013328	-	-	-
	NAT	-	-	0011411	-	0011924	0011914	-
	NAT	-	-	-	-	-	0014933	-
20 mm 163,5x323	LUX	-	0011929	-	-	-	-	-
SLAB A	SOFT	0014930	0011931	-	-	-	-	-
	SOFT 3D	-	-	-	0013445	-	-	-
20 mm 163,5x323	LUX	-	0011930	-	-	-	-	-
SLAB B	SOFT	-	0011932	-	-	-	-	-
	SOFT 3D	-	-	-	0013446	-	-	-

MATITE ALLUMINIO - ALUMINIUM STRIPS

Articoli realizzati in alluminio anodizzato per l'uso a parete, adatti a raccordare piastrelle di diverso spessore (8,5/7/6 mm). Avvertenze per la posa e la pulizia all'interno delle confezioni o sul sito Flaviaker.
Anodized Aluminium strips for use between wall tiles of different thicknesses (8,5/7/6 mm). Instructions for installation and cleaning included in the box or on flaviaker website.

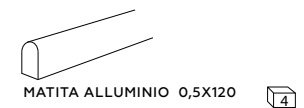

Parte superiore arrotondata. Rounded top.
MATITA ALLUMINIO
0000086 P. 24,50

Parte superiore arrotondata e colorata con resine acriliche.
Rounded top colored with acrylic resins.

MATITA ALLUM. ORO
0008535 P. 32,50

MATITA ALLUM. RAME SCURO
0008534 P. 32,50

MATITA ALLUM. WHITE
0000087 P. 32,50

MATITA ALLUM. TERRACOTTA
0008530 P. 32,50

MATITA ALLUM. BLU
0008532 P. 32,50

MATITA ALLUM. VERDE
0008531 P. 40,50

MATITA ALLUM. ARDESIA
0008533 P. 32,50

MATITA ALLUM. BLACK
0000088 P. 32,50

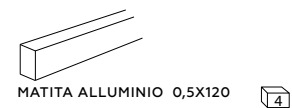

Parte superiore piatta colorata in bagno galvanico.
Flat top colored in galvanic bath.

MATITA ALLUM. BRONZO
0000557 P. 40,50

MATITA ALLUM. RAME
0000556 P. 40,50

Decor e Pezzi Speciali
Decors
and Special Trims

		Breccia Imperiale	Bianco Vagli	Dark Stone	Quarzite Luna	Grey Soapstone	Pulpis Ivory	Rosa Perlino	
<p>Battiscopa 5,5x120 8,5 mm</p>	LUX RETT.	0012681	0012679	-	0013320	-	0012680	-	P. 15,50
	NAT RETT. P. TECH R10 C	0012624	0012621	0012625	0013307	0012622	0012623	0012620	P. 11,50
	ANT. 3D RETT. 3D TECH.	0012650	0012647	0012651	0013312	0012648	0012649	0012646	P. 16,50
<p>Gradone Top 32x120x4,5x2 8,5 mm</p>	LUX RETT.	0012684	0012682	-	0013321	-	0012683	-	P. 205,50
	NAT RETT. P. TECH R10 C	0012630	0012627	0012631	0013308	0012628	0012629	0012626	P. 194,50
	ANT. 3D RETT. 3D TECH.	0012656	0012653	0012657	0013313	0012654	0012655	0012652	P. 226,50
<p>Angolare Top SX 32x120x4,5x2 8,5 mm</p>	LUX RETT.	0012687	0012685	-	0013322	-	0012686	-	P. 236,50
	NAT RETT. P. TECH R10 C	0012636	0012633	0012637	0013309	0012634	0012635	0012632	P. 225,50
	ANT. 3D RETT. 3D TECH.	0012662	0012659	0012663	0013314	0012660	0012661	0012658	P. 260,50
<p>Angolare Top DX 32x120x4,5x2 8,5 mm</p>	LUX RETT.	0012690	0012688	-	0013323	-	0012689	-	P. 236,50
	NAT RETT. P. TECH R10 C	0012642	0012639	0012643	0013310	0012640	0012641	0012638	P. 225,50
	ANT. 3D RETT. 3D TECH.	0012668	0012665	0012669	0013315	0012666	0012667	0012664	P. 260,50

GRES PORCELLANATO TUTTA MASSA
FULL BODY PORCELAIN

SUPERFICIE NAT. / SOFT / SOFT 3D CLASSIFICAZIONE SECONDO NORME EN 14411 (ISO 13006) ALLEGATO G GRUPPO B1a UGL
NAT. / SOFT / SOFT 3D SURFACE CLASSIFICATION IN ACCORDANCE WITH EN 14411 (ISO 13006) ANNEX G GROUP B1a UGL



PROPRIETÀ FISICO-CHIMICHE PHYSICAL-CHEMICAL PROPERTIES	NORMA NORM	VALORE PRESCRITTO DALLE NORME VALUE PRESCRIBED FROM THE NORMS	* VAL. / VALUE FLAVIKER NAT. P.TECH	* VAL. / VALUE FLAVIKER R11 P. TECH
	B.C.R.A. C.A.	a PERICOLOSA - DANGEROUSLY SLIPPERY 0,20 < μ < 0,39 SCIVOLosità ECCESSIVA - EXCESSIVELY SLIPPERY 0,40 < μ < 0,74 ATTRITO SODDISFACENTE - SATISFACTORY GRIP μ 0,75 ATTRITO ECCELLENTE - EXCELLENT GRIP	> 0,40	> 0,40
	B.C.R.A. G.B.		> 0,40	> 0,40
RESISTENZA ALLO SCIVOLAMENTO SLIP RESISTANCE	ASTM C 1028 (S.C.O.F.)	SLIP RESISTANT (> 0,60)	> 0,60 DRY > 0,60 WET	> 0,60 DRY > 0,60 WET
	DIN 51130	IN FUNZIONE DELL'AMBIENTE O DELLA ZONA DI LAVORO BASING ON THE ENVIRONMENT OR THE WORKING AREA	R10	R11
	DIN 51097	-	A+B+C	A+B+C
	ANSI A 137-1:2012 (D.C.O.F.)	> 0,42	> 0,42	> 0,42
	AS/NZS 4586:2013	SRV : 35 - 44	P3 WET	P4 WET
	BS 7976 - 2:2002	> 36	+36 WET	+36 WET

*Valori medi di produzione / Average production values

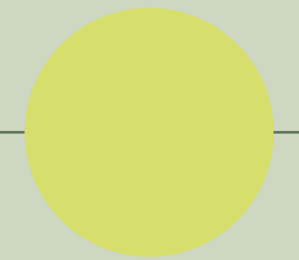

Projects

Marble	Supreme Memories
	Supreme Treasure Supreme Evo Supreme Classic Navona
Stone	Double Rockin' Blue Savoy Re_Tour Nordik Stone
Wood	Four Seasons Nordik Wood Cozy Flaviker-Dakota Zen
Metal	Rebel
Concrete	Hyper Backstage

Decor & Wall

	Art Walls Flow Chrome
--	-----------------------------

Outdoor

X20 - 20 mm	Supreme Memories
	Double Rockin' Hyper Blue Savoy Still No_w Rebel Nordik Stone Re_Tour Navona Four Seasons Nordik Wood Cozy Flaviker-Dakota
X30 - 30 mm	Backstage Nordik Stone Rebel Navona Flaviker-Dakota

Technical Information

BEST
BATHROOM
SUPREME
MEMORIES



Multiple Sensations

L'Ufficio Stile Flaviker ha costruito una materioteca in grado di dare vita a molteplici combinazioni. Qui trovi gli abbinamenti più interessanti realizzabili a partire da ciascun colore della gamma Supreme Memories.

Scopri anche i progetti "mix&match" studiati per questa collezione all'interno dell'ambiente bagno.

The Flaviker Style Department has assembled a collection of materials that can be used in many different combinations. Here you'll find the most interesting combinations that can be created using each colour in the Supreme Memories range.

You'll also discover mix&match solutions designed specifically for use of this collection in the bathroom.

Supreme Memories



Breccia Imperiale



Bianco Vagli



Dark Stone



Quarzite Luna



Grey Soapstone



Pulpis Ivory



Rosa Perlino

Rebel



WHITE



LEAD



WHITE



LEAD



BRONZE



LEAD



BRONZE

Hyper



GREY



TAUPE



WHITE



GREY



GREY



TAUPE



TAUPE

Four Seasons



HONEY



CHOCOLATE



HONEY



HONEY



HONEY



CHOCOLATE



CHOCOLATE



Index

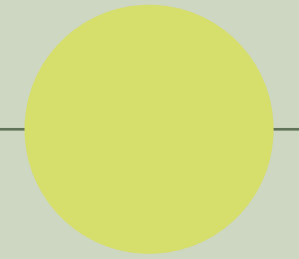

Projects

Marble	Supreme Memories Supreme Treasure Supreme Evo Supreme Classic Navona
Stone	Double Rockin' Blue Savoy Re_Tour Nordik Stone
Wood	Four Seasons Nordik Wood Cozy Flaviker-Dakota Zen
Metal	Rebel
Concrete	Hyper Backstage

Decor & Wall

Art Walls Flow Chrome

Outdoor

X20 - 20 mm	Supreme Memories Double Rockin' Hyper Blue Savoy Still No_w Rebel Nordik Stone Re_Tour Navona Four Seasons Nordik Wood Cozy Flaviker-Dakota
X30 - 30 mm	Backstage Nordik Stone Rebel Navona Flaviker-Dakota

Technical Information



+ Supreme Treasure

Gres porcellanato tutta massa **UGL**

Full body porcelain **UGL**

P. tech 3Dtech SOFT 3D



Complete Collection

Formati

Sizes

6 mm	
120x280	lux/soft/soft 3D
40x120	lux
8,5 mm	
120x120	nat/lux/ant. 3D
60x120	nat/lux/ant. 3D



Calacatta Emerald



Corchia Gold



Greylac Platinum



Luminous Everose



Cristallo Amber



Lasa Sapphire

Index

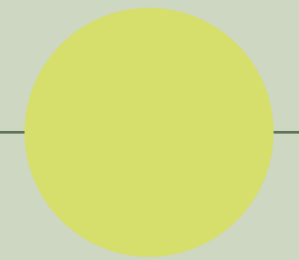

Projects

Marble	Supreme Memories		
	Supreme Treasure		
	Supreme Evo Supreme Classic Navona		
Stone	Double Rockin' Blue Savoy Re_Tour Nordik Stone		
	Wood	Four Seasons Nordik Wood Cozy Flaviker-Dakota Zen	
		Metal	Rebel
		Concrete	Hyper Backstage

Decor & Wall

Art Walls Flow Chrome

Outdoor

X20 - 20 mm	Supreme Memories
	Double
	Rockin'
	Hyper
	Blue Savoy
	Still No_w
	Rebel
	Nordik Stone
	Re_Tour
	Navona
	Four Seasons
X30 - 30 mm	Nordik Wood
	Cozy
	Flaviker-Dakota
	Backstage
	Nordik Stone
	Rebel
	Navona
	Flaviker-Dakota

Technical Information



+
 Supreme Treasure
 Calacatta Emerald
 Lux Rett. 60x120

+
 Nordik Wood
 Gold
 20x120

Marble

Supreme Treasure



Calacatta Emerald Corchia Gold Greylac Platinum Luminous Everose Cristallo Amber Lasa Sapphire

			Calacatta Emerald	Corchia Gold	Greylac Platinum	Luminous Everose	Cristallo Amber	Lasa Sapphire
6 mm	120x280 48"x112"	LUX RETT.	•	•	•	•	•	•
	120x280 48"x112"	SOFT RETT.	•	•		•	•	
	120x280 48"x112"	SOFT 3D RETT.			•			•
	40x120 16"x48"	LUX RETT.	•	•	•	•	•	•
8,5 mm	120x120 48"x48"	LUX RETT.	•	•	•	•	•	•
	120x120 48"x48"	NAT RETT. P. TECH R10 C	•	•	•	•	•	•
	120x120 48"x48"	ANT. 3D RETT. 3D TECH	•		•			
	60x120 24"x48"	LUX RETT.	•	•	•	•	•	•
	60x120 24"x48"	NAT RETT. P. TECH R10 C	•	•	•	•	•	•
	60x120 24"x48"	ANT. 3D RETT. 3D TECH	•		•			

Index

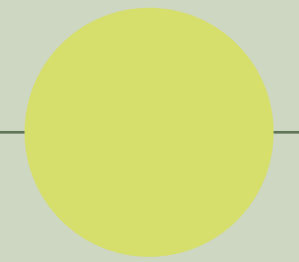

Projects

Material	Projects
Marble	Supreme Memories Supreme Treasure Supreme Evo Supreme Classic Navona
Stone	Double Rockin' Blue Savoy Re_Tour Nordik Stone
Wood	Four Seasons Nordik Wood Cozy Flaviker-Dakota Zen
Metal	Rebel
Concrete	Hyper Backstage

Decor & Wall

	Art Walls Flow Chrome
--	-----------------------------

Outdoor

X20 - 20 mm	Supreme Memories Double Rockin' Hyper Blue Savoy Still No_w Rebel Nordik Stone Re_Tour Navona Four Seasons Nordik Wood Cozy Flaviker-Dakota
X30 - 30 mm	Backstage Nordik Stone Rebel Navona Flaviker-Dakota

Technical Information

Calacatta Emerald

6 mm				
120x280	LUX R.	0008836	M.	122,50
	SOFT R.	0009001	M.	107,50
40x120	LUX R.	0008989	M.	99,90

8,5 mm				
120x120	LUX R.	0009021	M.	105,90
	NAT. R.	* P.TECH R10 C 0009063	M.	80,50
	ANT. 3D R.	3D TECH 0012588	M.	119,50
60x120	LUX R.	0009027	M.	80,50
	NAT. R.	* P.TECH R10 C 0009069	M.	61,90
	ANT. 3D R.	3D TECH 0012590	M.	88,50



CP3 Endless Match



6 mm				
120x280	360x280 CP3 ENDLESS LUX R.	0009006	P.	1558,50
	360x280 CP3 ENDLESS SOFT R.	0009010	P.	1391,50

Prezzo a CP / CP price

Ripresa grafica tra le diverse lastre contenuta entro una tolleranza di 3 cm. Composizione a 3 lastre non vendibili singolarmente.

Graphic clearance among the different slabs ranging within 3 cm. 3 Composition slabs not sold separately.

Corchia Gold

6 mm				
120x280	LUX R.	0008833	M.	122,50
	SOFT R.	0008998	M.	107,50
40x120	LUX R.	0008986	M.	99,90

8,5 mm				
120x120	LUX R.	0009018	M.	105,90
	NAT. R.	* P.TECH R10 C 0009060	M.	80,50
60x120	LUX R.	0009024	M.	80,50
	NAT. R.	* P.TECH R10 C 0009066	M.	61,90



CP3 Endless Match



6 mm				
120x280	360x280 CP3 ENDLESS LUX R.	0009004	P.	1558,50
	360x280 CP3 ENDLESS SOFT R.	0009008	P.	1391,50

Prezzo a CP / CP price

Ripresa grafica tra le diverse lastre contenuta entro una tolleranza di 3 cm. Composizione a 3 lastre non vendibili singolarmente.

Graphic clearance among the different slabs ranging within 3 cm. 3 Composition slabs not sold separately.

Index

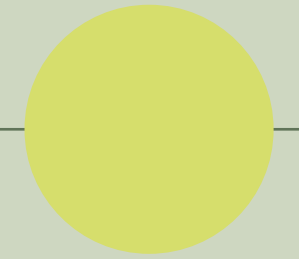

Projects

Marble	Supreme Memories
	Supreme Treasure
	Supreme Evo
	Supreme Classic
Stone	Navona
	Double
	Rockin'
	Blue Savoy
Wood	Re_Tour
	Nordik Stone
	Four Seasons
	Nordik Wood
Metal	Cozy
	Flaviker-Dakota
	Zen
	Rebel
Concrete	Hyper
	Backstage

Decor & Wall

Art Walls
Flow
Chrome

Outdoor

X20 - 20 mm	Supreme Memories
	Double
	Rockin'
	Hyper
	Blue Savoy
	Still No_w
	Rebel
	Nordik Stone
	Re_Tour
	Navona
	Four Seasons
X30 - 30 mm	Nordik Wood
	Cozy
	Flaviker-Dakota
	Backstage
	Nordik Stone
	Rebel
	Navona
	Flaviker-Dakota

Technical Information

Greylac Platinum

6 mm				
120x280	LUX R.		0008832	M. 122,50
	SOFT 3D R.	SOFT 3D	0008997	M. 113,50
40x120	LUX R.		0008985	M. 99,90
8,5 mm				
120x120	LUX R.		0009017	M. 105,90
	NAT. R.	* P.TECH R10 C	0009059	M. 80,50
	ANT. 3D R.	3D TECH	0012587	M. 119,50
60x120	LUX R.		0009023	M. 80,50
	NAT. R.	* P.TECH R10 C	0009065	M. 61,90
	ANT. 3D R.	3D TECH	0012589	M. 88,50



CP3 Endless Match



6 mm			
120x280	360x280 CP3 ENDLESS LUX R.	0009003	P. 1558,50
	360x280 CP3 ENDLESS SOFT 3D R.	0009007	P. 1461,50

Prezzo a CP / CP price
 Ripresa grafica tra le diverse lastre contenuta entro una tolleranza di 3 cm.
 Composizione a 3 lastre non vendibili singolarmente.
 Graphic clearance among the different slabs ranging within 3 cm.
 3 Composition slabs not sold separately.

Luminous Everose

6 mm				
120x280	LUX R.		0008834	M. 122,50
	SOFT R.		0008999	M. 107,50
40x120	LUX R.		0008987	M. 99,90
8,5 mm				
120x120	LUX R.		0009019	M. 105,90
	NAT. R.	* P.TECH R10 C	0009061	M. 80,50
	LUX R.		0009025	M. 80,50
60x120	LUX R.		0009067	M. 61,90



CP4 Endless Match



6 mm			
120x280	480x280 CP4 ENDLESS LUX R.	0009005	P. 2226,50
	480x280 CP4 ENDLESS SOFT R.	0009009	P. 1947,90

Prezzo a CP / CP price
 Ripresa grafica tra le diverse lastre contenuta entro una tolleranza di 3 cm.
 Composizione a 4 lastre non vendibili singolarmente.
 Graphic clearance among the different slabs ranging within 3 cm.
 4 Composition slabs not sold separately.

Index

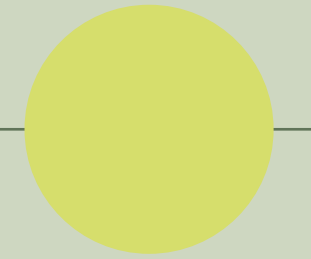

Projects

Marble	Supreme Memories
	Supreme Treasure
	Supreme Evo
	Supreme Classic
Stone	Navona
	Double
	Rockin'
	Blue Savoy
Wood	Re_Tour
	Nordik Stone
	Four Seasons
	Nordik Wood
Metal	Cozy
	Flaviker-Dakota
	Zen
	Rebel
Concrete	Hyper
	Backstage

Decor & Wall

Art Walls
Flow
Chrome

Outdoor

X20 - 20 mm	Supreme Memories
	Double
	Rockin'
	Hyper
	Blue Savoy
	Still No_w
	Rebel
	Nordik Stone
	Re_Tour
	Navona
	Four Seasons
	Nordik Wood
	Cozy
	Flaviker-Dakota
X30 - 30 mm	Backstage
	Nordik Stone
	Rebel
	Navona
Flaviker-Dakota	

Technical Information

Cristallo Amber

6 mm				
120x280	LUX R.	0008837	M.	122,50
	SOFT R.	0009002	M.	107,50
40x120	LUX R.	0008990	M.	99,90
8,5 mm				
120x120	LUX R.	0009022	M.	105,90
	NAT. R.	* P.TECH R10 C 0009064	M.	80,50
60x120	LUX R.	0009028	M.	80,50
	NAT. R.	* P.TECH R10 C 0009070	M.	61,90



Lasa Sapphire

6 mm				
120x280	LUX R.	0008835	M.	122,50
	SOFT 3D R.	SOFT 3D 0009000	M.	113,50
40x120	LUX R.	0008988	M.	99,90
8,5 mm				
120x120	LUX R.	0009020	M.	105,90
	NAT. R.	* P.TECH R10 C 0009062	M.	80,50
60x120	LUX R.	0009026	M.	80,50
	NAT. R.	* P.TECH R10 C 0009068	M.	61,90



MATERIA.

Disponibile anche Available also		Calacatta Emerald	Corchia Gold	Greylac Platinum	Luminous Everose	Cristallo Amber	Lasa Sapphire
LUX	-	0009215	0009214	-	0009216	0009276	
SOFT	-	0009218	-	-	0009219	-	
SOFT 3D	-	-	00011921	-	-	00011920	
12 mm 163,5x323		SLAB A LUX	0009829	-	-	-	
SLAB B LUX	0009831	-	-	-	-	-	
SLAB A SOFT	0009833	-	-	-	-	-	
SLAB B SOFT	0009835	-	-	-	-	-	
20 mm 163,5x323 FULLBODY3D		LUX	-	0010872	-	-	
SOFT	-	0009221	-	-	-	-	

MATITE ALLUMINIO - ALUMINIUM STRIPS

Articoli realizzati in alluminio anodizzato per l'uso a parete, adatti a raccordare piastrelle di diverso spessore (8,5/7/6 mm). Avvertenze per la posa e la pulizia all'interno delle confezioni o sul sito Flaviker. Anodized Aluminium strips for use between wall tiles of different thicknesses (8,5/7/6 mm). Instructions for installation and cleaning included in the box or on flaviker website.

 MATITA ALLUMINIO 0,5X120	 MATITA ALLUMINIO 0,5X120
Parte superiore arrotondata. Rounded top. MATITA ALLUMINIO 0000086 P. 24,50	Parte superiore piatta colorata in bagno galvanico. Flat top colored in galvanic bath.
	
MATITA ALLUM. WHITE 0000087 P. 32,50 MATITA ALLUM. TERRACOTTA 0008530 P. 32,50 MATITA ALLUM. BLU 0008532 P. 32,50 MATITA ALLUM. VERDE 0008531 P. 32,50 MATITA ALLUM. ARDESIA 0008533 P. 32,50 MATITA ALLUM. BLACK 0000088 P. 32,50	MATITA ALLUM. BRONZO 0000557 P. 40,50 MATITA ALLUM. RAME 0000556 P. 40,50

Index



Projects

Marble	Supreme Memories
	Supreme Treasure
	Supreme Evo
	Supreme Classic
	Navona
Stone	Double
	Rockin'
	Blue Savoy
	Re_Tour
	Nordik Stone
Wood	Four Seasons
	Nordik Wood
	Cozy
	Flaviker-Dakota
	Zen
Metal	Rebel
Concrete	Hyper
	Backstage

Decor & Wall

	Art Walls
	Flow
	Chrome

Outdoor

X20 - 20 mm	Supreme Memories
	Double
	Rockin'
	Hyper
	Blue Savoy
	Still No_w
	Rebel
	Nordik Stone
	Re_Tour
	Navona
	Four Seasons
	Nordik Wood
	Cozy
	Flaviker-Dakota
X30 - 30 mm	Backstage
	Nordik Stone
	Rebel
	Navona
	Flaviker-Dakota

Technical Information



Decori e Pezzi Speciali
Decors and Special Trims

	Calacatta Emerald	Corchia Gold	Greylac Platinum	Luminous Everose	Cristallo Amber	Lasa Sapphire	
Oblique 25x120 8,5 mm 2 = 0,46 MQ	LUX RETT. 0008884	0008881	0008880	0008882	0008885	0008883	M. 272,90
Mosaico Twist 30x30 8,5 mm 4	LUX RETT. 0008896	0008893	0008892	0008894	0008897	0008895	M. 206,90
Mosaico Sticks 30x30 8,5 mm 4	NAT / LUX RETT. 0008902	0008899	0008898	0008900	0008903	0008901	M. 206,90
Battiscopa 5,5x120 8,5 mm 6	LUX RETT. 0009033	0009030	0009029	0009031	0009034	0009032	P. 15,50
Gradone Top 32x120x4,5x2 8,5 mm 1	NAT. RETT. 0009075	0009072	0009071	0009073	0009076	0009074	P. 11,50
	ANT. 3D RETT. 0012592	-	0012591	-	-	-	P. 16,50
Angolare Top SX 32x120x4,5x2 8,5 mm 1	LUX RETT. 0009039	0009036	0009035	0009037	0009040	0009038	P. 205,50
	NAT. RETT. 0009081	0009078	0009077	0009079	0009082	0009080	P. 194,50
Angolare Top DX 32x120x4,5x2 8,5 mm 1	ANT. 3D RETT. 0012595	-	0012593	-	-	-	P. 226,50
	LUX RETT. 0009045	0009042	0009041	0009043	0009046	0009044	P. 236,50
Angolare Top SX 32x120x4,5x2 8,5 mm 1	NAT. RETT. 0009087	0009084	0009083	0009085	0009088	0009086	P. 225,50
	ANT. 3D RETT. 0012597	-	0012596	-	-	-	P. 260,50
Angolare Top DX 32x120x4,5x2 8,5 mm 1	LUX RETT. 0009051	0009048	0009047	0009049	0009052	0009050	P. 236,50
	NAT. RETT. 0009093	0009090	0009089	0009091	0009094	0009092	P. 225,50
ANT. 3D RETT. 0012599	-	0012598	-	-	-	-	P. 260,50

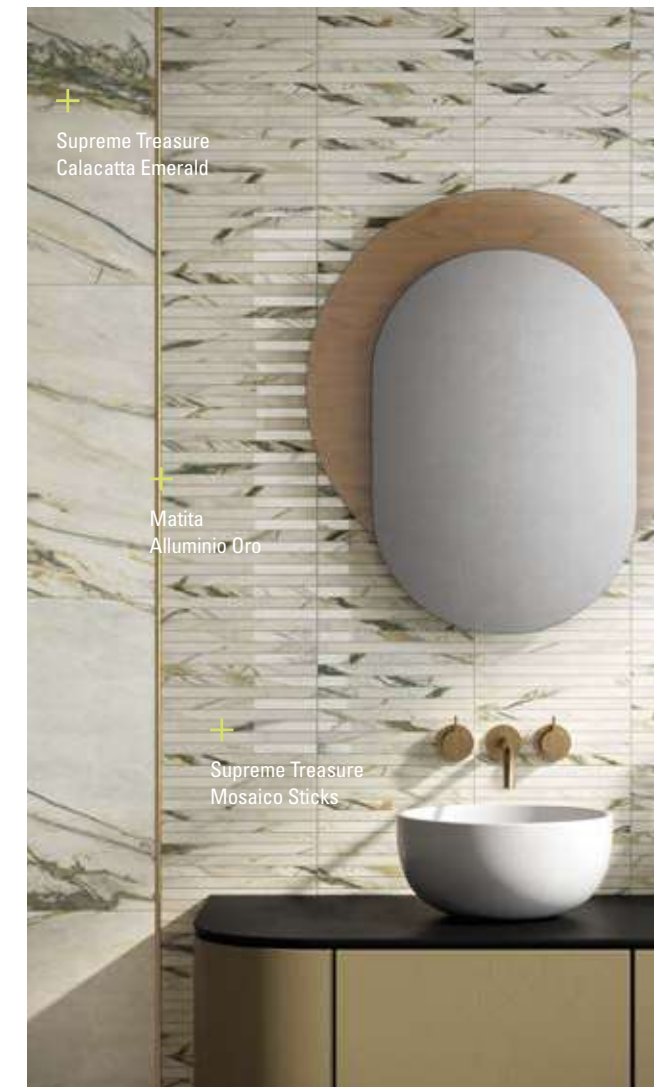

GRES PORCELLANATO TUTTA MASSA
FULL BODY PORCELAIN

SUPERFICIE NAT. / SOFT / SOFT 3D CLASSIFICAZIONE SECONDO NORME EN 14411 (ISO 13006) ALLEGATO G GRUPPO BIa UGL
NAT. / SOFT / SOFT 3D SURFACE CLASSIFICATION IN ACCORDANCE WITH EN 14411 (ISO 13006) ANNEX G GROUP BIa UGL



PROPRIETÀ FISICO-CHIMICHE PHYSICAL-CHEMICAL PROPERTIES	NORMA NORM	VALORE PRESCRITTO DALLE NORME VALUE PRESCRIBED FROM THE NORMS	* VAL. / VALUE FLAVIKER NAT. P.TECH
RESISTENZA ALLO SCIVOLAMENTO SLIP RESISTANCE	B.C.R.A. C.A.	a PERICOLOSA - DANGEROUSLY SLIPPERY 0,20 < μ < 0,39 SCIVOLosità ECCESSIVA - EXCESSIVELY SLIPPERY 0,40 < μ < 0,74 ATTRITO SODDISFACENTE - SATISFACTORY GRIP μ 0,75 ATTRITO ECCELLENTE - EXCELLENT GRIP	> 0,40
	B.C.R.A. G.B.		> 0,40
	ASTM C 1028 (S.C.O.F.)	SLIP RESISTANT (> 0,60)	> 0,60 DRY > 0,60 WET
	DIN 51130	IN FUNZIONE DELL'AMBIENTE O DELLA ZONA DI LAVORO BASING ON THE ENVIRONMENT OR THE WORKING AREA	R10
	DIN 51097	-	A+B+C
	ANSI A 137-1:2012 (D.C.O.F.)	> 0,42	> 0,42

*Valori medi di produzione / Average production values

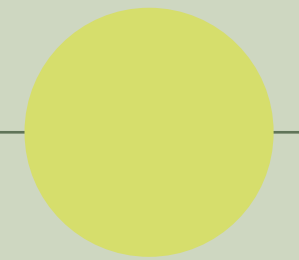

Projects

Marble	Supreme Memories Supreme Treasure Supreme Evo Supreme Classic Navona
Stone	Double Rockin' Blue Savoy Re_Tour Nordik Stone
Wood	Four Seasons Nordik Wood Cozy Flaviker-Dakota Zen
Metal	Rebel
Concrete	Hyper Backstage

Decor & Wall

Art Walls Flow Chrome

Outdoor

X20 - 20 mm	Supreme Memories Double Rockin' Hyper Blue Savoy Still No_w Rebel Nordik Stone Re_Tour Navona Four Seasons Nordik Wood Cozy Flaviker-Dakota
X30 - 30 mm	Backstage Nordik Stone Rebel Navona Flaviker-Dakota

Technical Information

Multiple Sensations

L'Ufficio Stile Flaviker ha costruito una materioteca in grado di dare vita a molteplici combinazioni. Qui trovi gli abbinamenti più interessanti realizzabili a partire da ciascun colore della gamma Supreme Treasure.

Scopri anche i progetti "mix&match" studiati per questa collezione all'interno dell'ambiente bagno.

The Flaviker Style Department has assembled a collection of materials that can be used in many different combinations. Here you'll find the most interesting combinations that can be created using each colour in the Supreme Treasure range.

You'll also discover mix&match solutions designed specifically for use of this collection in the bathroom.

BEST
BATHROOM
SUPREME
TREASURE



Supreme Treasure



Calacatta Emerald



Corchia Gold



Cristallo Amber



Greylac Platinum



Lasa Sapphire



Luminous Everose

Rebel



EMERALD



BRASS



BRONZE



BRASS

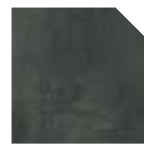

NIGHT



LEAD

Chrome



WHITE

Hyper



TAUPE

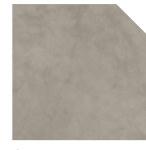

GREY



TAUPE

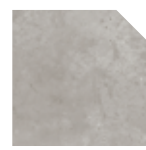

SILVER



SILVER



TAUPE



BLACK

Rockin'



ICE



LAVA



TAUPE



LAVA

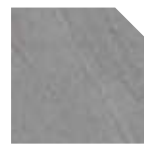

GREY



GREY

Re_tour



MUD



MUD



IVORY



MUD



FOG



FOG

Four Seasons



HONEY



HONEY



BISCUIT



CHOCOLATE



CHOCOLATE



BISCUIT

Nordik Wood



GOLD



GOLD



BROWN



BEIGE



BEIGE



BEIGE



Index

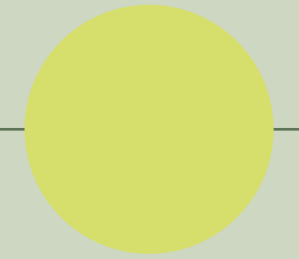

Projects

Marble	Supreme Memories Supreme Treasure Supreme Evo Supreme Classic Navona
Stone	Double Rockin' Blue Savoy Re_Tour Nordik Stone
Wood	Four Seasons Nordik Wood Cozy Flaviker-Dakota Zen
Metal	Rebel
Concrete	Hyper Backstage

Decor & Wall

Art Walls Flow Chrome

Outdoor

X20 - 20 mm	Supreme Memories Double Rockin' Hyper Blue Savoy Still No_w Rebel Nordik Stone Re_Tour Navona Four Seasons Nordik Wood Cozy Flaviker-Dakota
X30 - 30 mm	Backstage Nordik Stone Rebel Navona Flaviker-Dakota

Technical Information



Supreme Evo

Gres Porcellanato tutta massa UGL
Full Body Porcelain UGL

P. tech 3Dtech



Complete Collection

Formati

Sizes

6 mm
160x320 lux/soft
120x280 lux/soft

8,5 mm
120x120 nat/lux/ant. 3D
60x120 nat/lux/ant. 3D
80x80 nat/lux

Supreme Evo
Noir Laurent
Lux Rett. 120x280

Supreme Evo
Noir Laurent
Lux Rett. 120x120



Antique White

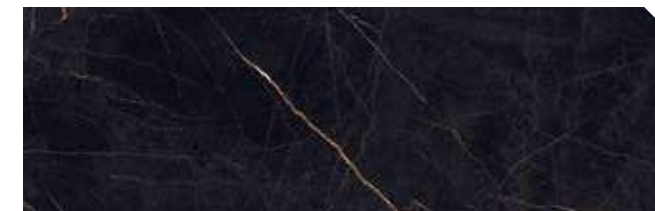

Noir Laurent



Invisible Select



Classic Marquinia



Statuario Superior



Grey Amani

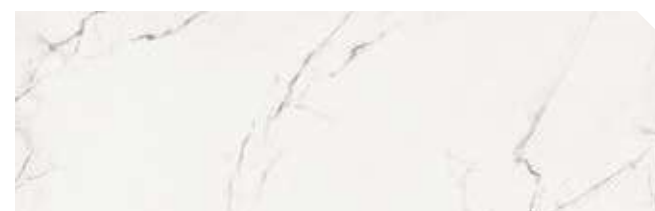

Pure Statuario

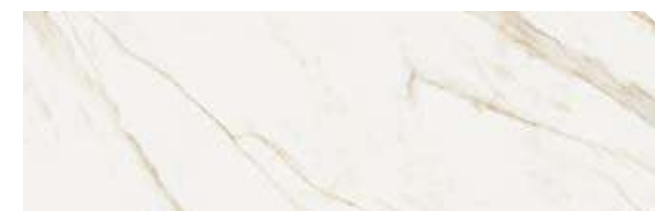

Calacatta Extra

Index

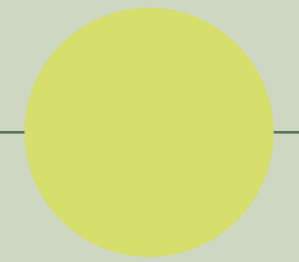

Projects

Marble	Supreme Memories Supreme Treasure Supreme Evo Supreme Classic Navona
Stone	Double Rockin' Blue Savoy Re_Tour Nordik Stone
Wood	Four Seasons Nordik Wood Cozy Flaviker-Dakota Zen
Metal	Rebel
Concrete	Hyper Backstage

Decor & Wall

Art Walls Flow Chrome

Outdoor

X20 - 20 mm	Supreme Memories Double Rockin' Hyper Blue Savoy Still No_w Rebel Nordik Stone Re_Tour Navona Four Seasons Nordik Wood Cozy Flaviker-Dakota
X30 - 30 mm	Backstage Nordik Stone Rebel Navona Flaviker-Dakota

Technical Information



+
 Supreme Evo
 Antique White
 Ant. 3D 120x120

Marble

Supreme Evo



Antique White Noir Laurent Invisible Select Classic Marquinia Statuario Superior Grey Amani Pure Statuario Calacatta Extra

			Antique White	Noir Laurent	Invisible Select	Classic Marquinia	Statuario Superior	Grey Amani	Pure Statuario	Calacatta Extra
6 mm	160x320 63"x126"	LUX RETT.	•	•			•		•	•
	160x320 63"x126"	SOFT RETT.	•	•			•			•
	120x280 48"x112"	LUX RETT.	•	•	•	•	•	•	•	•
	120x280 48"x112"	SOFT RETT.	•	•	•	•	•	•		
8,5 mm	120x120 48"x48"	LUX RETT.	•	•	•	•	•	•	•	•
	120x120 48"x48"	NAT RETT. P. TECH R10 C	•	•	•	•	•	•		
	120x120 48"x48"	ANT. 3D RETT. 3D TECH	•	•						
	60x120 24"x48"	LUX RETT.	•	•	•	•	•	•	•	•
	60x120 24"x48"	NAT RETT. P. TECH R10 C	•	•	•	•	•	•		
	60x120 24"x48"	ANT. 3D RETT. 3D TECH	•	•						
	80x80 32"x32"	LUX RETT.							•	•
80x80 32"x32"	NAT. RETT.							•	•	

Index

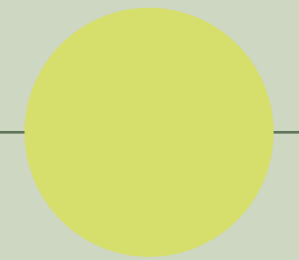

Projects

Material	Projects
Marble	Supreme Memories Supreme Treasure Supreme Evo Supreme Classic Navona
Stone	Double Rockin' Blue Savoy Re_Tour Nordik Stone
Wood	Four Seasons Nordik Wood Cozy Flaviker-Dakota Zen
Metal	Rebel
Concrete	Hyper Backstage

Decor & Wall

Art Walls Flow Chrome

Outdoor

Thickness	Projects
X20 - 20 mm	Supreme Memories Double Rockin' Hyper Blue Savoy Still No_w Rebel Nordik Stone Re_Tour Navona Four Seasons Nordik Wood Cozy Flaviker-Dakota
X30 - 30 mm	Backstage Nordik Stone Rebel Navona Flaviker-Dakota

Technical Information

Antique White

6 mm				
160x320 *	LUX R.	0003532	M.	151,50
	SOFT R.	0006189	M.	134,90
120x280 **	LUX R.	0008710	M.	122,50
	SOFT R.	0008713	M.	107,50
8,5 mm				
120x120	LUX R.	0003542	M.	105,90
	NAT. R.	*** P.TECH R10 C 0005732	M.	80,50
	ANT. 3D R.	3D TECH 0012602	M.	119,50
60x120	LUX R.	0003544	M.	80,50
	NAT. R.	*** P.TECH R10 C 0005737	M.	61,90
	ANT. 3D R.	3D TECH 0012604	M.	88,50



Noir Laurent

6 mm				
160x320 *	LUX R.	0002479	M.	151,50
	SOFT R.	0006762	M.	134,90
120x280 **	LUX R.	0008712	M.	122,50
	SOFT R.	0008714	M.	107,50
8,5 mm				
120x120	LUX R.	0002508 *	M.	105,90
	NAT. R.	*** P.TECH R10 C 0005733	M.	80,50
	ANT. 3D R.	3D TECH 0012603	M.	119,50
60x120	LUX R.	0002511 *	M.	80,50
	NAT. R.	*** P.TECH R10 C 0005738	M.	61,90
	ANT. 3D R.	3D TECH 0012605	M.	88,50



Invisible Select

6 mm				
120x280 **	LUX R.	0008702	M.	122,50
	SOFT R.	0008113	M.	107,50
8,5 mm				
120x120	LUX R.	0004199	M.	105,90
	NAT. R.	*** P.TECH R10 C 0005728	M.	80,50
60x120	LUX R.	0004204	M.	80,50
	NAT. R.	*** P.TECH R10 C 0005736	M.	61,90



Classic Marquinia

6 mm				
120x280 **	LUX R.	0008703	M.	122,50
	SOFT R.	0008114	M.	107,50
8,5 mm				
120x120	LUX R.	0004200	M.	105,90
	NAT. R.	*** P.TECH R10 C 0006755	M.	80,50
60x120	LUX R.	0004205	M.	80,50
	NAT. R.	*** P.TECH R10 C 0006756	M.	61,90



Index

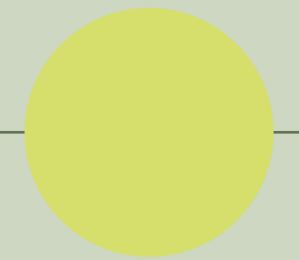

Projects

Marble	Supreme Memories
	Supreme Treasure
	Supreme Evo
	Supreme Classic
Stone	Navona
	Double
	Rockin'
	Blue Savoy
	Re_Tour
Wood	Nordik Stone
	Four Seasons
	Nordik Wood
	Cozy
	Flaviker-Dakota
	Zen
Metal	Rebel
Concrete	Hyper
	Backstage

Decor & Wall

Art Walls
Flow
Chrome

Outdoor

X20 - 20 mm	Supreme Memories
	Double
	Rockin'
	Hyper
	Blue Savoy
	Still No_w
	Rebel
	Nordik Stone
	Re_Tour
	Navona
	Four Seasons
	Nordik Wood
	Cozy
Flaviker-Dakota	
X30 - 30 mm	Backstage
	Nordik Stone
	Rebel
	Navona
	Flaviker-Dakota

Technical Information

56 * Fino ad esaurimento scorte l'art. verrà consegnato a spessore 7 mm. / The item will be delivered in a 7 mm thickness while stocks last.
 ** Fino ad esaurimento scorte l'art. verrà consegnato nel formato 120x278 o 120x270 spessore 6. / The item will be delivered in sizes 120x278 mm or 120x270 mm (thickness 6 mm) while stocks last.
 *** Gli articoli P.TECH verranno forniti ad esaurimento delle scorte di magazzino con superficie naturale. / P.TECH items will be supplied once natural surface stocks have run out.

* Fino ad esaurimento scorte l'art. verrà consegnato a spessore 7 mm. / The item will be delivered in a 7 mm thickness while stocks last.
 ** Fino ad esaurimento scorte l'art. verrà consegnato nel formato 120x278 o 120x270 spessore 6. / The item will be delivered in sizes 120x278 mm or 120x270 mm (thickness 6 mm) while stocks last.
 *** Gli articoli P.TECH verranno forniti ad esaurimento delle scorte di magazzino con superficie naturale. / P.TECH items will be supplied once natural surface stocks have run out.

Statuario Superior

6 mm				
160x320 *	LUX R.		0004176	M. 151,50
	SOFT R.		0003846	M. 134,90
120x280 **	LUX R.		0008701	M. 122,50
	SOFT R.		0008705	M. 107,50
8,5 mm				
120x120	LUX R.		0004198	M. 105,90
	NAT. R.	*** P.TECH R10 C	0005726	M. 80,50
60x120	LUX R.		0004203	M. 80,50
	NAT. R.	*** P.TECH R10 C	0005735	M. 61,90



Grey Amani

6 mm				
120x280 **	LUX R.		0008711	M. 122,50
	SOFT R.		0008116	M. 107,50
8,5 mm				
120x120	LUX R.		0002509 *	M. 105,90
	NAT. R.	*** P.TECH R10 C	0005734	M. 80,50
60x120	LUX R.		0002512 *	M. 80,50
	NAT. R.	*** P.TECH R10 C	0005739	M. 61,90



Pure Statuario

6 mm				
160x320 *	LUX R.		0000371	M. 151,50
	LUX R.		0008804	M. 122,50
8,5 mm				
120x120	LUX R.		0000389	M. 105,90
	LUX R.		0008815	M. 80,50
60x120 *	LUX R.		0000718	M. 78,90
	LUX R.	P.TECH R10 C	0000739	M. 55,90



Calacatta Extra

6 mm				
160x320 *	LUX R.		0000367	M. 151,50
	SOFT R.		0002751	M. 134,90
120x280	LUX R.		0008803	M. 122,50
8,5 mm				
120x120	LUX R.		0000385	M. 105,90
	LUX R.		0008814	M. 80,50
60x120 *	LUX R.		0000717	M. 78,90
	LUX R.	P.TECH R10 C	0000736	M. 55,90

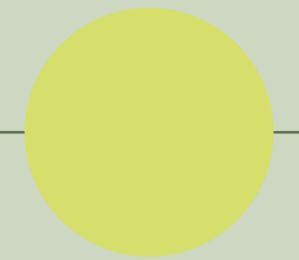
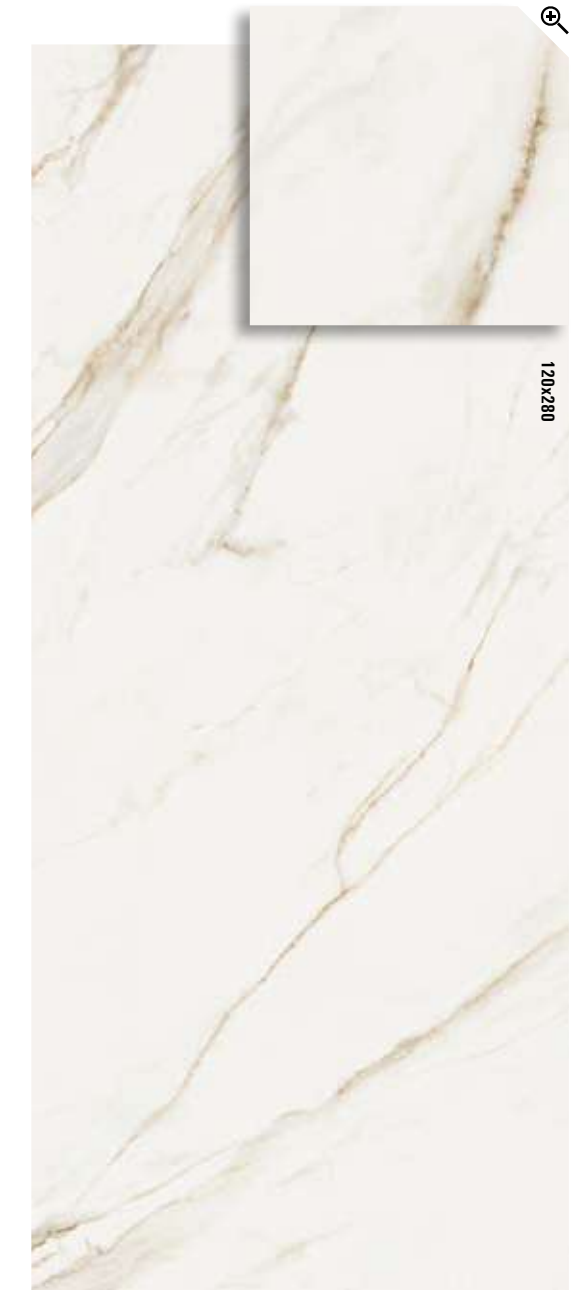

Projects

Marble	Supreme Memories
	Supreme Treasure
	Supreme Evo
	Supreme Classic
Stone	Navona
	Double
	Rockin'
	Blue Savoy
Wood	Re_Tour
	Nordik Stone
	Four Seasons
	Nordik Wood
Metal	Cozy
	Flaviker-Dakota
	Zen
	Rebel
Concrete	Hyper
	Backstage

Decor & Wall

Art Walls
Flow
Chrome

Outdoor

X20 - 20 mm	Supreme Memories
	Double
	Rockin'
	Hyper
	Blue Savoy
	Still No_w
	Rebel
	Nordik Stone
	Re_Tour
	Navona
	Four Seasons
	Nordik Wood
X30 - 30 mm	Cozy
	Flaviker-Dakota
	Backstage
	Nordik Stone
	Rebel
	Navona
	Flaviker-Dakota

Technical Information

58 * Fino ad esaurimento scorte l'art. verrà consegnato a spessore 7 mm. / The item will be delivered in a 7 mm thickness while stocks last.
 ** Fino ad esaurimento scorte l'art. verrà consegnato nel formato 120x278 o 120x270 spessore 6. / The item will be delivered in sizes 120x278 mm or 120x270 mm (thickness 6 mm) while stocks last.
 *** Gli articoli P.TECH verranno forniti ad esaurimento delle scorte di magazzino con superficie naturale. / P.TECH items will be supplied once natural surface stocks have run out.

* Fino ad esaurimento scorte l'art. verrà consegnato a spessore 7 mm. / The item will be delivered in a 7 mm thickness while stocks last.



Decori e Pezzi Speciali Decors and Special Trims		Antique White	Noir Laurent	Invisible Select	Classic Marquinia	Statuario Superior	Grey Amani	
	Oblique 25x120 8,5 mm 2 = 0,46 MQ	LUX RETT. 0008866	0008865	-	-	-	-	M. 272,90
	Mosaico Twist 30x30 8,5 mm 4	LUX RETT. 0008868	0008867	-	-	-	-	M. 206,90
	Mosaico Triangoli 34x26 8,5 mm 5	LUX -	0002528 *	-	-	-	0002529 *	M. 480,90
	Triangolo 30 8,5 mm 10 = 0,39 MQ	LUX -	-	-	-	-	0002515 *	M. 297,50
	Battiscopa 5,5x120 8,5 mm 6	LUX RETT. 0004913	0002516	0004910	0004911	0004909	0002517	P. 15,50
		NAT. RETT. 0005742	0005743	0005741	0006757	0005740	0005744	P. 11,50
		ANT. 3D RETT. 0012606	0012607	-	-	-	-	P. 16,50
	Gradone Top 32x120x4,5x2 8,5 mm 1	LUX RETT. 0004918	0002519	0004915	0004916	0004914	0002520	P. 205,50
		NAT. RETT. 0005747	0005748	0005746	0006758	0005745	0005749	P. 194,50
		ANT. 3D RETT. 0012608	0012609	-	-	-	-	P. 226,50
	Angolare Top SX 32x120x4,5x2 8,5 mm 1	LUX RETT. 0004923	0002522	0004920	0004921	0004919	0002523	P. 236,50
		NAT. RETT. 0005752	0005754	0005751	0006759	0005750	0005755	P. 225,50
		ANT. 3D RETT. 0012610	0012611	-	-	-	-	P. 260,50
	Angolare Top DX 32x120x4,5x2 8,5 mm 1	LUX RETT. 0004928	0002525	0004925	0004926	0004924	0002526	P. 236,50
		NAT. RETT. 0005758	0005759	0005757	0006760	0005756	0005760	P. 225,50
		ANT. 3D RETT. 0012612	0012613	-	-	-	-	P. 260,50



Decori e Pezzi Speciali Decors and Special Trims		Pure Statuario	Calacatta Extra	
	Mosaico Triangoli 34x26 7 mm 5	LUX 0000996	0000995	M. 606,90
	Triangolo 30 7 mm 14 = 0,54 MQ	LUX 0000413	0000412	M. 375,50
	Battiscopa * 5,5x120 8,5 mm 6	LUX RETT. 0000871	0000867	P. 15,50
	Gradone Top * 32x120x4,5x2 8,5 mm 1	LUX RETT. 0000877	0000873	P. 205,50
	Angolare Top SX * 32x120x4,5x2 8,5 mm 1	LUX RETT. 0000883	0000879	P. 236,50
	Angolare Top DX * 32x120x4,5x2 8,5 mm 1	LUX RETT. 0000889	0000885	P. 236,50

MATERIA.



Disponibile anche Available also		Antique White	Noir Laurent	Invisible Select	Classic Marquinia	Statuario Superior	Calacatta Extra
6 mm 163,5x323	LUX	0003893 SLAB A LUX 0009972 SLAB B LUX 0009924	0003364	0003889	0003891	SLAB A LUX 0003887 SLAB B LUX 0009923	0003353
	SOFT	0006186	0006219	0003835	0003856	0003836	0002742
12 mm 163,5x323	LUX	-	0003791	0003789	-	-	-
	SOFT	-	0006276	0003777	-	-	-
12 mm 163,5x323 SLAB A	LUX	0004697	-	-	0003788	0003786	0003787
	SOFT	0004695	-	-	0003776	0003774	0003775
12 mm 163,5x323 SLAB B	LUX	0004698	-	-	0003863	0003861	0003862
	SOFT	0004696	-	-	0003866	0003864	0003865
20 mm 163,5x323	LUX	0008337	0010871	-	0006245	0006243	0006244
	SOFT	0008335	0008029	0007762	0006248	0006246	0006247

GRES PORCELLANATO TUTTA MASSA
FULL BODY PORCELAIN

SUPERFICIE NAT. / SOFT CLASSIFICAZIONE SECONDO NORME EN 14411 (ISO 13006) ALLEGATO G GRUPPO BIa UGL
NAT. / SOFT SURFACE CLASSIFICATION IN ACCORDANCE WITH EN 14411 (ISO 13006) ANNEX G GROUP BIa UGL



PROPRIETÀ FISICO-CHIMICHE PHYSICAL-CHEMICAL PROPERTIES	NORMA NORM	VALORE PRESCRITTO DALLE NORME VALUE PRESCRIBED FROM THE NORMS	* VAL. / VALUE FLAVIKER NAT.	* VAL. / VALUE FLAVIKER NAT. P.TECH
	B.C.R.A. C.A.	a PERICOLOSA - DANGEROUSLY SLIPPERY 0,20 < μ < 0,39 SCIVOLosità ECCESSIVA - EXCESSIVELY SLIPPERY 0,40 < μ < 0,74 ATTRITO SODDISFACENTE - SATISFACTORY GRIP μ 0,75 ATTRITO ECCELLENTE - EXCELLENT GRIP	> 0,40	> 0,40
	B.C.R.A. G.B.		> 0,40	> 0,40
RESISTENZA ALLO SCIVOLAMENTO SLIP RESISTANCE	ASTM C 1028 (S.C.O.F.)	SLIP RESISTANT (> 0,60)	> 0,60 DRY > 0,60 WET	> 0,60 DRY > 0,60 WET
	DIN 51130	IN FUNZIONE DELL'AMBIENTE O DELLA ZONA DI LAVORO BASING ON THE ENVIRONMENT OR THE WORKING AREA	R10	R10
	DIN 51097	-	A+B	A+B+C
	ANSI A 137-1:2012 (D.C.O.F.)	> 0,42	> 0,42	> 0,42

*Valori medi di produzione / Average production values

P.tech ON DEMAND

La tecnologia P.TECH migliora le performance anti-scivolo dei pavimenti, mantenendo inalterati i valori di resistenza meccanica del gres porcellanato, con una finitura estremamente piacevole al tatto e facile da pulire. **SUPREME EVO PURE STATUARIO, CALACATTA EXTRA in finitura P.TECH, nei formati 120x120 e 60x120, può essere fornita su richiesta con un ordine soggetto a lotto minimo di produzione.**

The innovative P.TECH technology which improves the slip resistance of floors while delivering the renowned mechanical strength of porcelain stoneware and a finish that is both extremely pleasant to the touch and easy to clean. **PURE STATUARIO, CALACATTA EXTRA in P.TECH finish, in the 120x120 and 60x120 sizes, can be supplied on request with an order subject to a minimum production batch.**



Projects

Marble	Supreme Memories Supreme Treasure Supreme Evo Supreme Classic Navona
Stone	Double Rockin' Blue Savoy Re_Tour Nordik Stone
Wood	Four Seasons Nordik Wood Cozy Flaviker-Dakota Zen
Metal	Rebel
Concrete	Hyper Backstage

Decor & Wall

	Art Walls Flow Chrome
--	-----------------------------

Outdoor

X20 - 20 mm	Supreme Memories Double Rockin' Hyper Blue Savoy Still No_w Rebel Nordik Stone Re_Tour Navona Four Seasons Nordik Wood Cozy Flaviker-Dakota
X30 - 30 mm	Backstage Nordik Stone Rebel Navona Flaviker-Dakota

Technical Information

Multiple Sensations

L'Ufficio Stile Flaviker ha costruito una materioteca in grado di dare vita a molteplici combinazioni. Qui trovi gli abbinamenti più interessanti realizzabili a partire da ciascun colore della gamma Supreme Evo.

Scopri anche i progetti "mix&match" studiati per questa collezione all'interno dell'ambiente bagno.

The Flaviker Style Department has assembled a collection of materials that can be used in many different combinations. Here you'll find the most interesting combinations that can be created using each colour in the Supreme Evo range.

You'll also discover mix&match solutions designed specifically for use of this collection in the bathroom.

BEST
BATHROOM
SUPREME
EVO



Supreme Evo



Antique White



Noir Laurent



Invisible Select



Classic Marquinia



Statuario Superior



Grey Amani



Pure Statuario



Calacatta Extra

Rebel



BRASS



BRONZE



LEAD



WHITE



SILVER

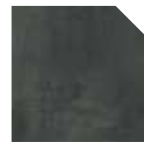

NIGHT

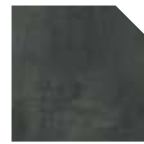

NIGHT



BRONZE

Hyper



TAUPE

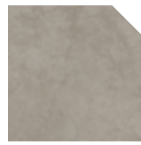

GREY



TAUPE

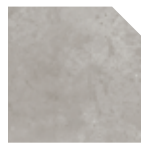

SILVER



GREY



TAUPE

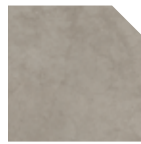

GREY



TAUPE

Four Seasons



HONEY



HONEY



BISCUIT



HONEY



CHOCOLATE



CHOCOLATE



CHOCOLATE



CHOCOLATE

Nordik Wood



GOLD



GOLD



SMOKED



SAND



SMOKED



GOLD



GOLD



GOLD



+
Re_Tour
Fog

+
Supreme Evo
Pure Statuario

+
Nordik Wood
Gold

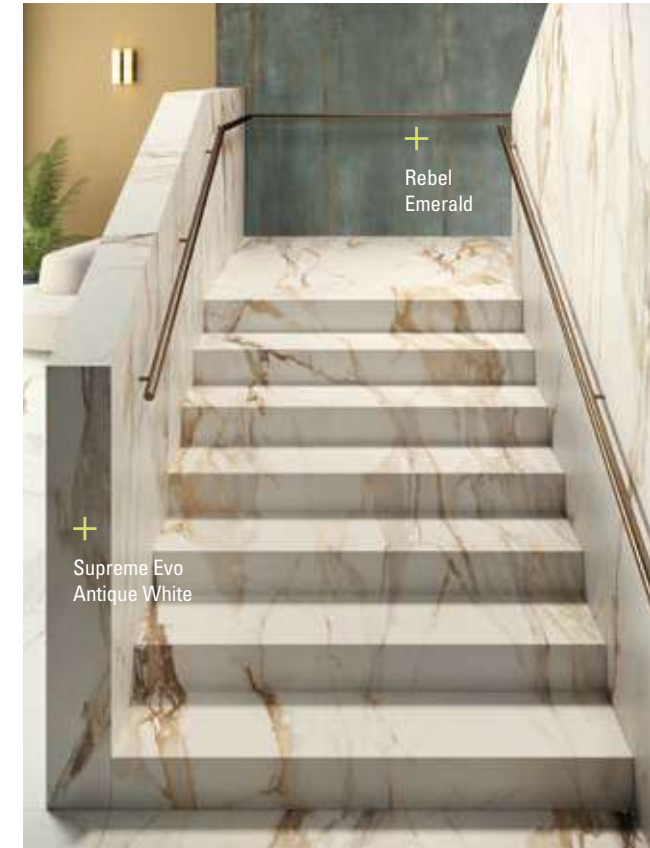

+
Rebel
Emerald

+
Supreme Evo
Antique White



+
Supreme Evo
Invisible Select

+
Hyper
Taupe



+
Supreme Evo
Noir Laurent

+
Four Seasons
Honey

Index

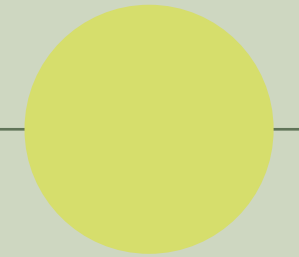

Projects

Marble	Supreme Memories Supreme Treasure Supreme Evo Supreme Classic Navona
Stone	Double Rockin' Blue Savoy Re_Tour Nordik Stone
Wood	Four Seasons Nordik Wood Cozy Flaviker-Dakota Zen
Metal	Rebel
Concrete	Hyper Backstage

Decor & Wall

	Art Walls Flow Chrome
--	-----------------------------

Outdoor

X20 - 20 mm	Supreme Memories Double Rockin' Hyper Blue Savoy Still No_w Rebel Nordik Stone Re_Tour Navona Four Seasons Nordik Wood Cozy Flaviker-Dakota
X30 - 30 mm	Backstage Nordik Stone Rebel Navona Flaviker-Dakota

Technical Information



+
 Supreme Classic
 Onyx Prestige
 Lux Rett. 60x120

Marble



Supreme Classic

Gres porcellanato a massa colorata
 Full body colored porcelain



Complete Collection

Formati

Sizes

8,5 mm

60x120

lux/ant.



Golden Calacatta



Onyx Prestige



Royal Statuario

Index

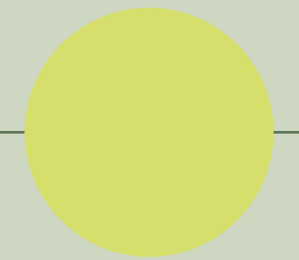

Projects

Marble	Supreme Memories Supreme Treasure Supreme Evo Supreme Classic Navona
Stone	Double Rockin' Blue Savoy Re_Tour Nordik Stone
Wood	Four Seasons Nordik Wood Cozy Flaviker-Dakota Zen
Metal	Rebel
Concrete	Hyper Backstage

Decor & Wall

Art Walls Flow Chrome

Outdoor

X20 - 20 mm	Supreme Memories Double Rockin' Hyper Blue Savoy Still No_w Rebel Nordik Stone Re_Tour Navona Four Seasons Nordik Wood Cozy Flaviker-Dakota
X30 - 30 mm	Backstage Nordik Stone Rebel Navona Flaviker-Dakota

Technical Information

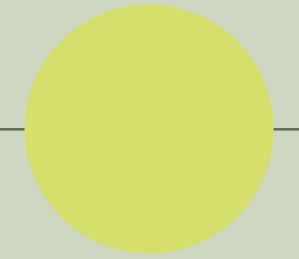

Golden Calacatta

8,5 mm				
60x120	LUX R.	SP 6113 L	M. 75,90	
	ANT. R.	SP 6113 P	M. 69,90	



Onyx Prestige

8,5 mm				
60x120	LUX R.	SP 6134 L	M. 75,90	
	ANT. R.	SP 6134 P	M. 69,90	



Royal Statuario

8,5 mm				
60x120	LUX R.	SP 6110 L	M. 75,90	
	ANT. R.	SP 6110 P	M. 69,90	



Decor
e Pezzi Speciali
Decors
and Special Trims



Golden Calacatta Onyx Prestige Royal Statuario

	Mix Floor 60x120 60x120 1 pz 60x80 1 pz 60x40 1 pz	ANT RETT.	SP FLO 13	SP FLO 34	SP FLO 10	M. 99,90
	Mosaico Hexagon 51x29,2	ANT RETT.	SP ES 13P	SP ES 34P	SP ES 10P	M. 138,50
	Mosaico 30x30	ANT/LUX RETT.	SP MO 133	SP MO 343	SP MO 103	M. 285,90
	Mosaico 5x5 30x30	ANT RETT.	SP MP 131	SP MP 341	SP MP 101	M. 119,50
	Battiscopa 5,5x60	LUX RETT.	SP BL 136A	SP BL 346A	SP BL 106A	P. 11,50
	Battiscopa 5,5x60	ANT RETT.	SP BP 136A	SP BP 346A	SP BP 106A	P. 9,90
	Gradone Top 32x120x4,5x2	LUX RETT.	SP RL 132	SP RL 342	SP RL 102	P. 205,50
	Gradone Top 32x120x4,5x2	ANT RETT.	SP RP 132	SP RP 342	SP RP 102	P. 205,50
	Angolare Top SX 32x120x4,5x2	LUX RETT.	SP RS 13L	SP RS 34L	SP RS 10L	P. 236,50
	Angolare Top SX 32x120x4,5x2	ANT RETT.	SP RS 13P	SP RS 34P	SP RS 10P	P. 236,50
	Angolare Top DX 32x120x4,5x2	LUX RETT.	SP RD 13L	SP RD 34L	SP RD 10L	P. 236,50
	Angolare Top DX 32x120x4,5x2	ANT RETT.	SP RD 13P	SP RD 34P	SP RD 10P	P. 236,50

5x60
SP DP 001 LISTONE RAME
P. 38,50

5x60
SP DP 002 LISTONE NICHEL
P. 38,50

GRES PORCELLANATO A MASSA COLORATA
FULL BODY COLORED PORCELAIN

CLASSIFICAZIONE SECONDO NORME EN 14411 (ISO 13006) ALLEGATO G GRUPPO BIa GL
SURFACE CLASSIFICATION IN ACCORDANCE WITH EN 14411 (ISO 13006) ANNEX G GROUP BIa GL



Projects

Marble	Supreme Memories Supreme Treasure Supreme Evo Supreme Classic Navona
Stone	Double Rockin' Blue Savoy Re_Tour Nordik Stone
Wood	Four Seasons Nordik Wood Cozy Flaviker-Dakota Zen
Metal	Rebel
Concrete	Hyper Backstage

Decor & Wall

	Art Walls Flow Chrome
--	-----------------------------

Outdoor

X20 - 20 mm	Supreme Memories Double Rockin' Hyper Blue Savoy Still No_w Rebel Nordik Stone Re_Tour Navona Four Seasons Nordik Wood Cozy Flaviker-Dakota
X30 - 30 mm	Backstage Nordik Stone Rebel Navona Flaviker-Dakota

Technical Information



+
Navona
Honey Vein
120x280

+
Rebel
Bronze
120x280

+
Navona
Honey Cross
80x80

+ Navona

Gres porcellanato tutta massa **UGL**
Full body porcelain **UGL**

P. tech



Complete Collection

Formati

Sizes

6 mm

160x320 nat
120x280 nat

8,5 mm

120x120 nat
60x120 nat
80x80 nat
60x60 nat/R11
30x60 nat/R11

20 mm X20

60x120 R11
60x90 R11
60x60 R11

30 mm X30

60x60 R11



Honey Vein



Honey Cross



Bone Vein



Bone Cross



Grey Vein



Grey Cross

Index

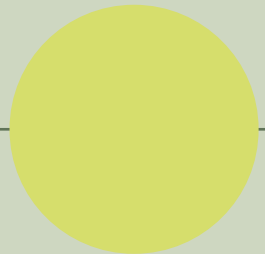

Projects

Marble	Supreme Memories Supreme Treasure Supreme Evo Supreme Classic Navona
Stone	Double Rockin' Blue Savoy Re_Tour Nordik Stone
Wood	Four Seasons Nordik Wood Cozy Flaviker-Dakota Zen
Metal	Rebel
Concrete	Hyper Backstage

Decor & Wall

	Art Walls Flow Chrome
--	-----------------------------

Outdoor

X20 - 20 mm	Supreme Memories Double Rockin' Hyper Blue Savoy Still No_w Rebel Nordik Stone Re_Tour Navona Four Seasons Nordik Wood Cozy Flaviker-Dakota
X30 - 30 mm	Backstage Nordik Stone Rebel Navona Flaviker-Dakota

Technical Information



+ Navona Honey Vein 120x280

+ Navona Honey Vein 120x280

+ Navona Honey Vein 60x120

Marble

Navona



Honey Vein Honey Cross Bone Vein Bone Cross Grey Vein Grey Cross

Thickness	Size	Finish	Honey Vein	Honey Cross	Bone Vein	Bone Cross	Grey Vein	Grey Cross
6 mm	160x320 63"x126"	NAT RETT.	•					
	120x280 48"x112"	NAT RETT.	•		•		•	
8,5 mm	120x120 48"x48"	NAT RETT. P. TECH R10 C	•	•	•	•	•	•
	60x120 24"x48"	NAT RETT. P. TECH R10 C	•	•	•	•	•	•
	80x80 32"x32"	NAT RETT. P. TECH R10 C	•	•	•	•	•	•
	60x60 24"x24"	NAT RETT. P. TECH R10 C	•	•	•	•	•	•
	60x60 24"x24"	R11 RETT. P.TECH	•	•	•	•	•	•
20 mm	30x60 12"x24"	NAT RETT. P. TECH R10 C	•	•	•	•	•	•
	30x60 12"x24"	R11 RETT. P.TECH	•	•	•	•	•	•
	60x120 24"x48"	R11 RETT. P.TECH	•		•			
30 mm	60x90 24"x36"	R11 RETT. P.TECH	•	•				
	60x60 24"x24"	R11 RETT. P.TECH	•	•				
	60x60 24"x24"	R11 RETT.		•				

Index

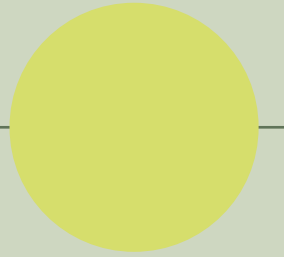

Projects

Material	Projects
Marble	Supreme Memories Supreme Treasure Supreme Evo Supreme Classic Navona
Stone	Double Rockin' Blue Savoy Re_Tour Nordik Stone
Wood	Four Seasons Nordik Wood Cozy Flaviker-Dakota Zen
Metal	Rebel
Concrete	Hyper Backstage

Decor & Wall

Art Walls Flow Chrome

Outdoor

Thickness	Projects
X20 - 20 mm	Supreme Memories Double Rockin' Hyper Blue Savoy Still No_w Rebel Nordik Stone Re_Tour Navona Four Seasons Nordik Wood Cozy Flaviker-Dakota
X30 - 30 mm	Backstage Nordik Stone Rebel Navona Flaviker-Dakota

Technical Information

Honey Vein

6 mm			
160x320	NAT. R.	0005917	M. 126,50
120x280 *	NAT. R.	0008104	M. 101,90

8,5 mm			
120x120	NAT. R.	P.TECH R10 C	0005210 M. 80,50
60x120	NAT. R.	P.TECH R10 C	0005214 M. 61,90
80x80	NAT. R.	P.TECH R10 C	0005928 M. 55,90
60x60	NAT. R.	P.TECH R10 C	0006607 M. 51,50
	R11 R.	P.TECH	0007730 M. 51,50
30x60	NAT. R.	P.TECH R10 C	0007214 M. 46,90
	R11 R.	P.TECH	0007733 M. 46,90

20 mm X20			
60x120	R11 R.	P.TECH	0011595 M. 87,90
60x90	R11 R.	P.TECH	0007180 M. 83,50
60x60	R11 R.	P.TECH	0012104 M. 73,50



Honey Cross

8,5 mm			
120x120	NAT. R.	P.TECH R10 C	0005938 M. 80,50
60x120	NAT. R.	P.TECH R10 C	0005941 M. 61,90
80x80	NAT. R.	P.TECH R10 C	0005950 M. 55,90
60x60	NAT. R.	P.TECH R10 C	0006592 M. 51,50
	R11 R.	P.TECH	0006601 M. 51,50
30x60	NAT. R.	P.TECH R10 C	0007217 M. 46,90
	R11 R.	P.TECH	0007739 M. 46,90

20 mm X20			
60x90	R11 R.	P.TECH	0007181 M. 83,50
60x60	R11 R.	P.TECH	0012103 M. 73,50

30 mm X30			
60x60	R11 R.		0009239 M. 120,50



Bone Vein

6 mm			
120x280 *	NAT. R.		0008664 M. 101,90

8,5 mm			
120x120	NAT. R.	P.TECH R10 C	0005209 M. 80,50
60x120	NAT. R.	P.TECH R10 C	0005213 M. 61,90
80x80	NAT. R.	P.TECH R10 C	0005927 M. 55,90
60x60	NAT. R.	P.TECH R10 C	0006606 M. 51,50
	R11 R.	P.TECH	0007729 M. 51,50
30x60	NAT. R.	P.TECH R10 C	0007213 M. 46,90
	R11 R.	P.TECH	0007732 M. 46,90

20 mm X20			
60x120	R11 R.	P.TECH	0011594 M. 87,90



Bone Cross

8,5 mm			
120x120	NAT. R.	P.TECH R10 C	0005937 M. 80,50
60x120	NAT. R.	P.TECH R10 C	0005940 M. 61,90
80x80	NAT. R.	P.TECH R10 C	0005949 M. 55,90
60x60	NAT. R.	P.TECH R10 C	0006591 M. 51,50
	R11 R.	P.TECH	0006600 M. 51,50
30x60	NAT. R.	P.TECH R10 C	0007216 M. 46,90
	R11 R.	P.TECH	0007738 M. 46,90



Index

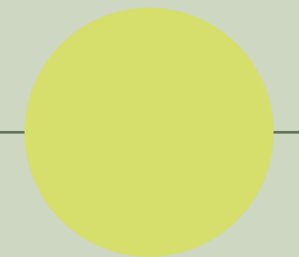

Projects

Marble	Supreme Memories Supreme Treasure Supreme Evo Supreme Classic Navona
Stone	Double Rockin' Blue Savoy Re_Tour Nordik Stone
Wood	Four Seasons Nordik Wood Cozy Flaviker-Dakota Zen
Metal	Rebel
Concrete	Hyper Backstage

Decor & Wall

	Art Walls Flow Chrome
--	-----------------------------

Outdoor

X20 - 20 mm	Supreme Memories Double Rockin' Hyper Blue Savoy Still No_w Rebel Nordik Stone Re_Tour Navona Four Seasons Nordik Wood Cozy Flaviker-Dakota
X30 - 30 mm	Backstage Nordik Stone Rebel Navona Flaviker-Dakota

Technical Information

Grey Vein

6 mm				
120x280*	NAT. R.		0008665	M. 101,90

8,5 mm				
120x120	NAT. R.	P.TECH R10 C	0005921	M. 80,50
60x120	NAT. R.	P.TECH R10 C	0005922	M. 61,90
80x80	NAT. R.	P.TECH R10 C	0005929	M. 55,90
60x60	NAT. R.	P.TECH R10 C	0006608	M. 51,50
	R11 R.	P.TECH	0007731	M. 51,50
30x60	NAT. R.	P.TECH R10 C	0007215	M. 46,90
	R11 R.	P.TECH	0007734	M. 46,90



Grey Cross

8,5 mm				
120x120	NAT. R.	P.TECH R10 C	0005939	M. 80,50
60x120	NAT. R.	P.TECH R10 C	0005942	M. 61,90
80x80	NAT. R.	P.TECH R10 C	0005951	M. 55,90
60x60	NAT. R.	P.TECH R10 C	0006593	M. 51,50
	R11 R.	P.TECH	0006602	M. 51,50
30x60	NAT. R.	P.TECH R10 C	0007218	M. 46,90
	R11 R.	P.TECH	0007740	M. 46,90



Decorie Pezzi Speciali
Decors and Special Trims



		Honey Vein	Honey Cross	Bone Vein	Bone Cross	Grey Vein	Grey Cross	
Mosaico 30x30 8,5 mm	NAT RETT.	0006595 Mix Vein / Cross		0006594 Mix Vein / Cross		0006596 Mix Vein / Cross		M. 119,50
Battiscopa 5,5x60 8,5 mm	NAT RETT.	0006782	0006800	0006781	0006799	0006783	0006801	P. 7,90
Battiscopa 5,5x80 8,5 mm	NAT RETT.	0006779	0006797	0006778	0006796	0006780	0006798	P. 9,90
Gradone Top 32x120x4,5x2 8,5 mm	NAT RETT.	0006785	0006803	0006784	0006802	0006786	0006804	P. 194,50
Angolare Top SX 32x120x4,5x2 8,5 mm	NAT RETT.	0006788	0006806	0006787	0006805	0006789	0006807	P. 225,50
Angolare Top DX 32x120x4,5x2 8,5 mm	NAT RETT.	0006791	0006809	0006790	0006808	0006792	0006810	P. 225,50

MATERIA.

Disponibile anche Available also		Honey Vein	Honey Cross	Bone Vein	Bone Cross	Grey Vein	Grey Cross
6 mm							
163,5x323	NAT	0005916	-	-	-	-	-
12 mm							
163,5x323	NAT	0005364	-	0012117	-	-	-
20 mm							
163,5x323	NAT	-	-	0014932	-	-	-

Index



Projects

Marble	Supreme Memories Supreme Treasure Supreme Evo Supreme Classic Navona
Stone	Double Rockin' Blue Savoy Re_Tour Nordik Stone
Wood	Four Seasons Nordik Wood Cozy Flaviker-Dakota Zen
Metal	Rebel
Concrete	Hyper Backstage

Decor & Wall

	Art Walls Flow Chrome
--	-----------------------------

Outdoor

X20 - 20 mm	Supreme Memories Double Rockin' Hyper Blue Savoy Still No_w Rebel Nordik Stone Re_Tour Navona Four Seasons Nordik Wood Cozy Flaviker-Dakota
X30 - 30 mm	Backstage Nordik Stone Rebel Navona Flaviker-Dakota

Technical Information



40x120
0007075
HONEY VEIN RETT.
M. 69,90 6 mm



40x120
0007077
DIAMONDS HONEY VEIN RETT.
M. 79,90 6 mm

PASTA BIANCA DA RIVESTIMENTO
WHITE BODY WALL TILES
CLASSIFICAZIONE SECONDO NORME EN 14411 (ISO 13006) ALLEGATO L GRUPPO BIII
CLASSIFICATION IN ACCORDANCE WITH EN 14411 (ISO 13006) ANNEX L GROUP BIII



Maita
Alluminio
Bronzo

Navona
Diamonds
Honey Vein

Navona
Honey Vein
40x120

GRES PORCELLANATO TUTTA MASSA
FULL BODY PORCELAIN

CLASSIFICAZIONE SECONDO NORME EN 14411 (ISO 13006) ALLEGATO G GRUPPO BIa UGL
CLASSIFICATION IN ACCORDANCE WITH EN 14411 (ISO 13006) ANNEX G GROUP BIa UGL



PROPRIETÀ FISICO-CHIMICHE PHYSICAL-CHEMICAL PROPERTIES	NORMA NORM	VALORE PRESCRITTO DALLE NORME VALUE PRESCRIBED FROM THE NORMS	* VAL. / VALUE FLAVIKER NAT.	* VAL. / VALUE FLAVIKER NAT. P.TECH	* VAL. / VALUE FLAVIKER R11 P.TECH
	B.C.R.A. C.A.	μ 0,19 SCIVOLosità PERICOLOSA - DANGEROUSLY SLIPPERY $0,20 < \mu < 0,39$ SCIVOLosità ECCESSIVA - EXCESSIVELY SLIPPERY $0,40 < \mu < 0,74$ ATTRITO SODDISFACENTE - SATISFACTORY GRIP μ 0,75 ATTRITO ECCELLENTE - EXCELLENT GRIP	> 0,40	> 0,40	> 0,40
	B.C.R.A. G.B.		> 0,40	> 0,40	> 0,40
	ASTM C 1028 (S.C.O.F.)	SLIP RESISTANT (> 0,60)	> 0,60 DRY > 0,60 WET	> 0,60 DRY > 0,60 WET	> 0,60 DRY > 0,60 WET
	DIN 51130	IN FUNZIONE DELL'AMBIENTE O DELLA ZONA DI LAVORO BASING ON THE ENVIRONMENT OR THE WORKING AREA	R10	R10	R11
RESISTENZA ALLO SCIVOLAMENTO SLIP RESISTANCE	DIN 51097	-	A+B	A+B+C	A+B+C
	ANSI A 137-1:2012 (D.C.O.F.)	> 0,42	> 0,42	> 0,42	> 0,42
	AS/NZS 4586:2013	SRV : 35 - 44	-	P3 WET	P4 WET
	BS 7976 - 2:2002	> 36	-	+36 WET	+36 WET

*Valori medi di produzione / Average production values

MATITE ALLUMINIO - ALUMINIUM STRIPS

Articoli realizzati in alluminio anodizzato per l'uso a parete, adatti a raccordare piastrelle di diverso spessore (8,5/7/6 mm). Avvertenze per la posa e la pulizia all'interno delle confezioni o sul sito Flaviker.
Anodized Aluminium strips for use between wall tiles of different thicknesses (8,5/7/6 mm). Instructions for installation and cleaning included in the box or on flaviker website.

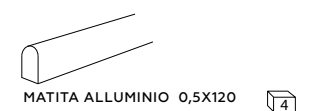

Parte superiore arrotondata. Rounded top.
MATITA ALLUMINIO
0000086 P. 24,50

Parte superiore arrotondata e colorata con resine acriliche.
Rounded top colored with acrylic resins.

MATITA ALLUM. ORO
0008535 P. 32,50

MATITA ALLUM. RAME SCURO
0008534 P. 32,50

MATITA ALLUM. WHITE
0000087 P. 32,50

MATITA ALLUM. TERRACOTTA
0008530 P. 32,50

MATITA ALLUM. BLU
0008532 P. 32,50

MATITA ALLUM. VERDE
0008531 P. 32,50

MATITA ALLUM. ARDESIA
0008533 P. 32,50

MATITA ALLUM. BLACK
0000088 P. 32,50

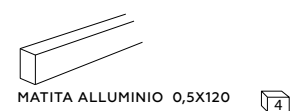

Parte superiore piatta colorata in bagno galvanico
Flat top colored in galvanic bath.

MATITA ALLUM. BRONZO
0000557 P. 40,50

MATITA ALLUM. RAME
0000556 P. 40,50

Index



Projects

Marble	Supreme Memories Supreme Treasure Supreme Evo Supreme Classic Navona
Stone	Double Rockin' Blue Savoy Re_Tour Nordik Stone
Wood	Four Seasons Nordik Wood Cozy Flaviker-Dakota Zen
Metal	Rebel
Concrete	Hyper Backstage

Decor & Wall

Art Walls Flow Chrome

Outdoor

X20 - 20 mm	Supreme Memories Double Rockin' Hyper Blue Savoy Still No_w Rebel Nordik Stone Re_Tour Navona Four Seasons Nordik Wood Cozy Flaviker-Dakota
X30 - 30 mm	Backstage Nordik Stone Rebel Navona Flaviker-Dakota

Technical Information

Multiple Sensations

BEST
BATHROOM
NAVONA



L'Ufficio Stile Flaviker ha costruito una materioteca in grado di dare vita a molteplici combinazioni. Qui trovi gli abbinamenti più interessanti realizzabili a partire da ciascun colore della gamma Navona.

Scopri anche i progetti "mix&match" studiati per questa collezione all'interno dell'ambiente bagno.

The Flaviker Style Department has assembled a collection of materials that can be used in many different combinations. Here you'll find the most interesting combinations that can be created using each colour in the Navona range.

You'll also discover mix&match solutions designed specifically for use of this collection in the bathroom.

Navona



Honey Vein



Honey Cross



Bone Vein



Bone Cross



Grey Vein



Grey Cross

Rebel



BRONZE



BRONZE



BRASS



BRASS



LEAD



LEAD

Chrome



WHITE



BLACK

Four Seasons



CHOCOLATE



CHOCOLATE



BISCUIT



BISCUIT



HONEY



HONEY

Nordik Wood



BROWN



BROWN



BEIGE



BEIGE



SMOKED



SMOKED

Cozy



DESERT



DESERT



BROWN



BROWN



HAVANA



HAVANA



Index

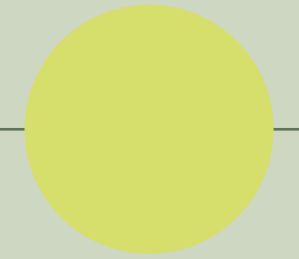

Projects

Marble	Supreme Memories Supreme Treasure Supreme Evo Supreme Classic Navona
Stone	Double Rockin' Blue Savoy Re_Tour Nordik Stone
Wood	Four Seasons Nordik Wood Cozy Flaviker-Dakota Zen
Metal	Rebel
Concrete	Hyper Backstage

Decor & Wall

	Art Walls Flow Chrome
--	-----------------------------

Outdoor

X20 - 20 mm	Supreme Memories Double Rockin' Hyper Blue Savoy Still No_w Rebel Nordik Stone Re_Tour Navona Four Seasons Nordik Wood Cozy Flaviker-Dakota
X30 - 30 mm	Backstage Nordik Stone Rebel Navona Flaviker-Dakota

Technical Information



Stone

+ Double

Gres porcellanato tutta massa **UGL**

Full body porcelain **UGL**

P. tech 3Dtech



Complete Collection

Formati

Sizes

6 mm
120x280 nat/lux 3D

8,5 mm
80x160 nat
120x120 nat/lux 3D
60x120 nat/lux 3D
80x80 nat

20 mm X20
60x120 R11
60x60 R11



Linear White

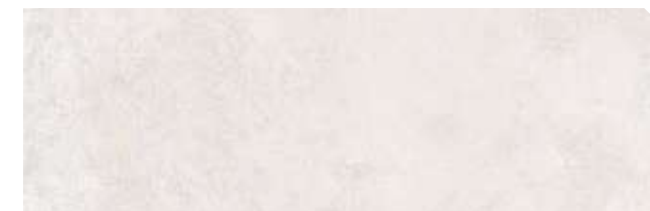

Plain White



Linear Beige

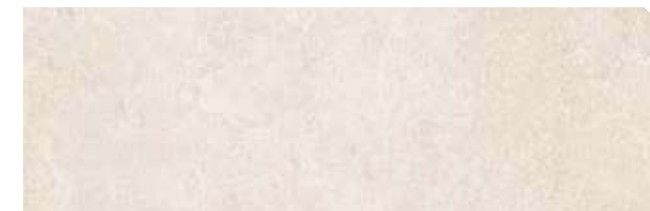

Plain Beige



Linear Grey



Plain Grey



Linear Mint



Plain Mint

Index

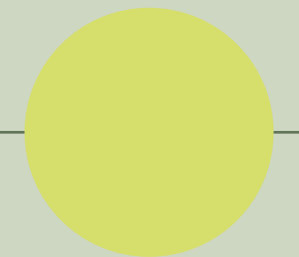

Projects

Marble	Supreme Memories Supreme Treasure Supreme Evo Supreme Classic Navona
Stone	Double Rockin' Blue Savoy Re_Tour Nordik Stone
Wood	Four Seasons Nordik Wood Cozy Flaviker-Dakota Zen
Metal	Rebel
Concrete	Hyper Backstage

Decor & Wall

Art Walls Flow Chrome

Outdoor

X20 - 20 mm	Supreme Memories Double Rockin' Hyper Blue Savoy Still No_w Rebel Nordik Stone Re_Tour Navona Four Seasons Nordik Wood Cozy Flaviker-Dakota
X30 - 30 mm	Backstage Nordik Stone Rebel Navona Flaviker-Dakota

Technical Information



+
Double
Plain Beige
60x120

+
Double
Linear Beige
120x280

+
Four Seasons
Biscuit
26x200

Stone

Double



Plain White Linear White Plain Beige Linear Beige Plain Grey Linear Grey Plain Mint Linear Mint

Thickness	Size	Finish	Plain White	Linear White	Plain Beige	Linear Beige	Plain Grey	Linear Grey	Plain Mint	Linear Mint
6 mm	120x280 48"x112"	LUX 3D RETT.		•		•				
	120x280 48"x112"	NAT RETT. P. TECH R10 C	•	•	•	•	•	•	•	•
8,5 mm	80x160 32"x64"	NAT RETT. P. TECH R10 C	•	•	•	•	•	•	•	•
	120 x120 48"x48"	LUX 3D RETT.		•		•				
	120x120 48"x48"	NAT RETT. P. TECH R10 C	•	•	•	•	•	•	•	•
	60x120 24"x48"	LUX 3D RETT.		•		•				
	60x120 24"x48"	NAT RETT. P. TECH R10 C	•	•	•	•	•	•	•	•
20 mm	60x120 24"x48"	R11 RETT. P.TECH			•	•	•	•		
	60x60 24"x24"	R11 RETT. P.TECH			•		•			

Index

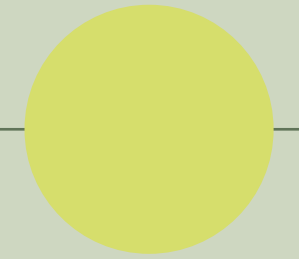

Projects

Material	Projects
Marble	Supreme Memories Supreme Treasure Supreme Evo Supreme Classic Navona
Stone	Double Rockin' Blue Savoy Re_Tour Nordik Stone
Wood	Four Seasons Nordik Wood Cozy Flaviker-Dakota Zen
Metal	Rebel
Concrete	Hyper Backstage

Decor & Wall

Art Walls Flow Chrome

Outdoor

Thickness	Projects
X20 - 20 mm	Supreme Memories Double Rockin' Hyper Blue Savoy Still No_w Rebel Nordik Stone Re_Tour Navona Four Seasons Nordik Wood Cozy Flaviker-Dakota
X30 - 30 mm	Backstage Nordik Stone Rebel Navona Flaviker-Dakota

Technical Information

Plain White

6 mm				
120x280	NAT. R.	P.TECH R10 C	0014840	M. 102,50

8,5 mm				
80x160	NAT. R.	P.TECH R10 C	0014831	M. 84,50
120x120	NAT. R.	P.TECH R10 C	0014148	M. 84,50
60x120	NAT. R.	P.TECH R10 C	0014153	M. 64,90
80x80	NAT. R.	P.TECH R10 C	0014835	M. 59,50



120x280

Linear White

6 mm				
120x280	LUX 3D R.	3D TECH	0014222	M. 138,50
	NAT. R.	P.TECH R10 C	0014219	M. 102,50

8,5 mm				
80x160	NAT. R.	P.TECH R10 C	0014604	M. 84,50
120x120	LUX 3D R.	3D TECH	0014225	M. 119,50
	NAT. R.	P.TECH R10 C	0014189	M. 84,50
60x120	LUX 3D R.	3D TECH	0014228	M. 88,50
	NAT. R.	P.TECH R10 C	0014192	M. 64,90
80x80	NAT. R.	P.TECH R10 C	0014823	M. 59,50



120x120

Plain Beige

6 mm				
120x280	NAT. R.	P.TECH R10 C	0014842	M. 102,50

8,5 mm				
80x160	NAT. R.	P.TECH R10 C	0014833	M. 84,50
120x120	NAT. R.	P.TECH R10 C	0014150	M. 84,50
60x120	NAT. R.	P.TECH R10 C	0014155	M. 64,90
80x80	NAT. R.	P.TECH R10 C	0014837	M. 59,50

20 mm				
60x120	R11 R.	P.TECH	0014304	M. 87,90
60x60	R11 R.	P.TECH	0016218	M. 73,50



120x120

Linear Beige

6 mm				
120x280	LUX 3D R.	3D TECH	0014224	M. 138,50
	NAT. R.	P.TECH R10 C	0014221	M. 102,50

8,5 mm				
80x160	NAT. R.	P.TECH R10 C	0014606	M. 84,50
120x120	LUX 3D R.	3D TECH	0014227	M. 119,50
	NAT. R.	P.TECH R10 C	0014191	M. 84,50
60x120	LUX 3D R.	3D TECH	0014230	M. 88,50
	NAT. R.	P.TECH R10 C	0014194	M. 64,90
80x80	NAT. R.	P.TECH R10 C	0014825	M. 59,50

20 mm				
60x120	R11 R.	P.TECH	0014302	M. 87,90



120x280

Index



Projects

Marble	Supreme Memories Supreme Treasure Supreme Evo Supreme Classic Navona
Stone	Double Rockin' Blue Savoy Re_Tour Nordik Stone
Wood	Four Seasons Nordik Wood Cozy Flaviker-Dakota Zen
Metal	Rebel
Concrete	Hyper Backstage

Decor & Wall

Art Walls Flow Chrome

Outdoor

X20 - 20 mm	Supreme Memories Double Rockin' Hyper Blue Savoy Still No_w Rebel Nordik Stone Re_Tour Navona Four Seasons Nordik Wood Cozy Flaviker-Dakota
X30 - 30 mm	Backstage Nordik Stone Rebel Navona Flaviker-Dakota

Technical Information

Plain Grey

6 mm				
120x280	NAT. R.	P.TECH R10 C	0014841	M. 102,50

8,5 mm				
80x160	NAT. R.	P.TECH R10 C	0014832	M. 84,50
120x120	NAT. R.	P.TECH R10 C	0014149	M. 84,50
60x120	NAT. R.	P.TECH R10 C	0014154	M. 64,90
80x80	NAT. R.	P.TECH R10 C	0014836	M. 59,50

20 mm X20				
60x120	R11 R.	P.TECH	0014303	M. 87,90
60x60	R11 R.	P.TECH	0016217	M. 73,50



60x120

Linear Grey

6 mm				
120x280	NAT. R.	P.TECH R10 C	0014220	M. 102,50

8,5 mm				
80x160	NAT. R.	P.TECH R10 C	0014605	M. 84,50
120x120	NAT. R.	P.TECH R10 C	0014190	M. 84,50
60x120	NAT. R.	P.TECH R10 C	0014193	M. 64,90
80x80	NAT. R.	P.TECH R10 C	0014824	M. 59,50

20 mm X20				
60x120	R11 R.	P.TECH	0014301	M. 87,90



120x280

Plain Mint

6 mm				
120x280	NAT. R.	P.TECH R10 C	0014843	M. 102,50

8,5 mm				
80x160	NAT. R.	P.TECH R10 C	0014834	M. 84,50
120x120	NAT. R.	P.TECH R10 C	0014151	M. 84,50
60x120	NAT. R.	P.TECH R10 C	0014156	M. 64,90
80x80	NAT. R.	P.TECH R10 C	0014838	M. 59,50



120x280

Linear Mint

6 mm				
120x280	NAT. R.	P.TECH R10 C	0014311	M. 102,50

8,5 mm				
80x160	NAT. R.	P.TECH R10 C	0014822	M. 84,50
120x120	NAT. R.	P.TECH R10 C	0014313	M. 84,50
60x120	NAT. R.	P.TECH R10 C	0014315	M. 64,90
80x80	NAT. R.	P.TECH R10 C	0014826	M. 59,50



60x120

Index

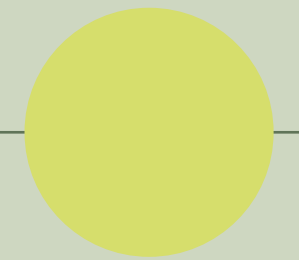

Projects

Marble	Supreme Memories Supreme Treasure Supreme Evo Supreme Classic Navona
Stone	Double Rockin' Blue Savoy Re_Tour Nordik Stone
Wood	Four Seasons Nordik Wood Cozy Flaviker-Dakota Zen
Metal	Rebel
Concrete	Hyper Backstage

Decor & Wall

	Art Walls Flow Chrome
--	-----------------------------

Outdoor

X20 - 20 mm	Supreme Memories Double Rockin' Hyper Blue Savoy Still No_w Rebel Nordik Stone Re_Tour Navona Four Seasons Nordik Wood Cozy Flaviker-Dakota
X30 - 30 mm	Backstage Nordik Stone Rebel Navona Flaviker-Dakota

Technical Information

P. tech



120x280
0015185
LEVELS GREY NAT. RETT.
M. 122,50

6 mm

P. TECH R10 C

3D tech



120x280
0015126 *
TANGRAM WHITE LUX 3D RETT.
M. 183,50

6 mm

3D TECH

3D tech

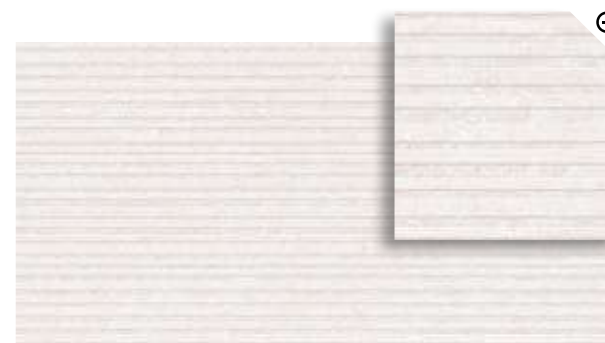

60x120
0015189 **
CANNETÈ WHITE NAT. RETT.
M. 84,50

8,5 mm

3D TECH



60x120
0015336 **
ARROW NAT. RETT.
M. 84,50

8,5 mm

3D TECH



60x120
0015190 **
CANNETÈ BEIGE NAT. RETT.
M. 84,50

8,5 mm

3D TECH



60x120
0015334 **
CANNETÈ GREY NAT. RETT.
M. 84,50

8,5 mm

3D TECH

CANNETÈ

Questo articolo ha una struttura 3D asimmetrica, pertanto è necessario seguire sempre lo stesso senso di posa.
This item has an asymmetrical 3D structure. It's important to install the product following always the same laying direction.

* Articolo composto da pattern grafici diversi che non prevedono agganci tra loro e miscelati in modo casuale. Non si garantisce pertanto la presenza costante di tutti i soggetti.
This item is produced with different graphic patterns, randomly packed and delivered.

** Articolo composto da pattern grafici diversi che prevedono agganci e che sono miscelati in modo casuale. Non si garantisce pertanto la presenza costante di tutti i soggetti all'interno delle confezioni. This item is produced with different graphic patterns with hooks, randomly packed and delivered.

Articoli con ripresa grafica tra le diverse lastre contenuta entro una tolleranza massima di 3mm. Item with a graphic clearance among the different slabs ranging within 3mm.

Index

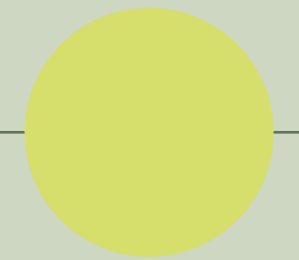

Projects

Marble	Supreme Memories Supreme Treasure Supreme Evo Supreme Classic Navona
Stone	Double Rockin' Blue Savoy Re_Tour Nordik Stone
Wood	Four Seasons Nordik Wood Cozy Flaviker-Dakota Zen
Metal	Rebel
Concrete	Hyper Backstage

Decor & Wall

	Art Walls Flow Chrome
--	-----------------------------

Outdoor

X20 - 20 mm	Supreme Memories Double Rockin' Hyper Blue Savoy Still No_w Rebel Nordik Stone Re_Tour Navona Four Seasons Nordik Wood Cozy Flaviker-Dakota
X30 - 30 mm	Backstage Nordik Stone Rebel Navona Flaviker-Dakota

Technical Information

MATERIA.



Disponibile anche Available also		Plain White	Linear White
12 mm 163,5x323	NAT	0014643	0014642
20 mm 163,5x323	NAT	0014935	0014934

Decorie Pezzi Speciali
Decors and Special Trims



			Plain White	Linear White	Plain Beige	Linear Beige	Plain Grey	Linear Grey	Plain Mint	Linear Mint	
 8,5 mm	Battiscopa 5,5x120	NAT RETT. P. TECH R10 C	0014888	0014884	0014890	0014886	0014889	0014885	0014891	0014887	P. 11,50
		LUX 3D RETT.	-	0016044	-	0016045	-	-	-	-	P. 16,50
 8,5 mm	Gradone Top 32x120x4,5x2	NAT RETT. P. TECH R10 C	0014912	0014900	0014914	0014902	0014913	0014901	0014915	0014903	P. 194,50
		LUX 3D RETT.	-	0016046	-	0016047	-	-	-	-	P. 226,50
 8,5 mm	Angolare Top SX 32x120x4,5x2	NAT RETT. P. TECH R10 C	0014916	0014904	0014918	0014906	0014917	0014905	0014919	0014907	P. 225,50
		LUX 3D RETT.	-	0016048	-	0016049	-	-	-	-	P. 260,50
 8,5 mm	Angolare Top DX 32x120x4,5x2	NAT RETT. P. TECH R10 C	0014920	0014908	0014922	0014910	0014921	0014909	0014923	0014911	P. 225,50
		LUX 3D RETT.	-	0016050	-	0016051	-	-	-	-	P. 260,50

MATITE ALLUMINIO - ALUMINIUM STRIPS

Articoli realizzati in alluminio anodizzato per l'uso a parete, adatti a raccordare piastrelle di diverso spessore (8,5/7/6 mm). Avvertenze per la posa e la pulizia all'interno delle confezioni o sul sito Flaviker.
Anodized Aluminium strips for use between wall tiles of different thicknesses (8,5/7/6 mm). Instructions for installation and cleaning included in the box or on flaviker website.

 MATITA ALLUMINIO 0,5X120 Parte superiore arrotondata. Rounded top. MATITA ALLUMINIO 0000086 P. 24,50	 MATITA ALLUM. WHITE 0000087 P. 32,50 MATITA ALLUM. TERRACOTTA 0008530 P. 32,50	 MATITA ALLUMINIO 0,5X120 Parte superiore piatta colorata in bagno galvanico. Flat top colored in galvanic bath.
 MATITA ALLUM. BLU 0008532 P. 32,50 MATITA ALLUM. VERDE 0008531 P. 32,50 MATITA ALLUM. ORO 0008535 P. 32,50 MATITA ALLUM. RAME SCURO 0008534 P. 32,50	 MATITA ALLUM. BRONZO 0000557 P. 40,50 MATITA ALLUM. RAME 0000556 P. 40,50 MATITA ALLUM. ARDESIA 0008533 P. 32,50 MATITA ALLUM. BLACK 0000088 P. 32,50	

GRES PORCELLANATO TUTTA MASSA
FULL BODY PORCELAIN

SUPERFICIE NATURALE CLASSIFICAZIONE SECONDO NORME EN 14411 (ISO 13006) ALLEGATO G GRUPPO BIa UGL
NATURAL SURFACE CLASSIFICATION IN ACCORDANCE WITH EN 14411 (ISO 13006) ANNEX G GROUP BIa UGL



PROPRIETÀ FISICO-CHIMICHE PHYSICAL-CHEMICAL PROPERTIES	NORMA NORM	VALORE PRESCRITTO DALLE NORME VALUE PRESCRIBED FROM THE NORMS	* VAL. / VALUE FLAVIKER NAT. P.TECH	* VAL. / VALUE FLAVIKER R11 P. TECH
	B.C.R.A. C.A.	a PERICOLOSA - DANGEROUSLY SLIPPERY 0,20 < μ < 0,39 SCIVOLosità ECCESSIVA - EXCESSIVELY SLIPPERY 0,40 < μ < 0,74 ATTRITO SODDISFACENTE - SATISFACTORY GRIP μ 0,75 ATTRITO ECCELLENTE - EXCELLENT GRIP	> 0,40	> 0,40
	B.C.R.A. G.B.		> 0,40	> 0,40
RESISTENZA ALLO SCIVOLAMENTO SLIP RESISTANCE	ASTM C 1028 (S.C.O.F.)	SLIP RESISTANT (> 0,60)	> 0,60 DRY > 0,60 WET	> 0,60 DRY > 0,60 WET
	DIN 51130	IN FUNZIONE DELL'AMBIENTE O DELLA ZONA DI LAVORO BASING ON THE ENVIRONMENT OR THE WORKING AREA	R10	R11
	DIN 51097	-	A+B+C	A+B+C
	ANSI A 137-1:2012 (D.C.O.F.)	> 0,42	> 0,42	> 0,42
	AS/NZS 4586:2013	SRV : 35 - 44	P3 WET	P4 WET
	BS 7976 - 2:2002	> 36	+36 WET	+36 WET

*Valori medi di produzione / Average production values

Index



Projects

Material	Projects
Marble	Supreme Memories Supreme Treasure Supreme Evo Supreme Classic Navona
Stone	Double Rockin' Blue Savoy Re_Tour Nordik Stone
Wood	Four Seasons Nordik Wood Cozy Flaviker-Dakota Zen
Metal	Rebel
Concrete	Hyper Backstage

Decor & Wall

	Art Walls Flow Chrome
--	-----------------------------

Outdoor

X20 - 20 mm	Supreme Memories Double Rockin' Hyper Blue Savoy Still No_w Rebel Nordik Stone Re_Tour Navona Four Seasons Nordik Wood Cozy Flaviker-Dakota
X30 - 30 mm	Backstage Nordik Stone Rebel Navona Flaviker-Dakota

Technical Information

Multiple Sensations

BEST
BATHROOM
DOUBLE



L'Ufficio Stile Flaviker ha costruito una materioteca in grado di dare vita a molteplici combinazioni. Qui trovi gli abbinamenti più interessanti realizzabili a partire da ciascun colore della gamma Double.

Scopri anche i progetti "mix&match" studiati per questa collezione all'interno dell'ambiente bagno.

The Flaviker Style Department has assembled a collection of materials that can be used in many different combinations. Here you'll find the most interesting combinations that can be created using each colour in the Double range.

You'll also discover mix&match solutions designed specifically for use of this collection in the bathroom.

Double

Double	Four Seasons	Supreme Memories	Rebel
Linear White	CHOCOLATE	DARK STONE	SILVER
Plain White	CHOCOLATE	DARK STONE	SILVER
Linear Beige	BISCUIT	BRECCIA IMPERIALE	BRASS
Plain Beige	BISCUIT	BRECCIA IMPERIALE	BRASS
Linear Grey	HONEY	BIANCO VAGLI	BRONZE
Plain Grey	HONEY	BIANCO VAGLI	BRONZE
Linear Mint	HONEY	BRECCIA IMPERIALE	SILVER
Plain Mint	HONEY	BRECCIA IMPERIALE	SILVER

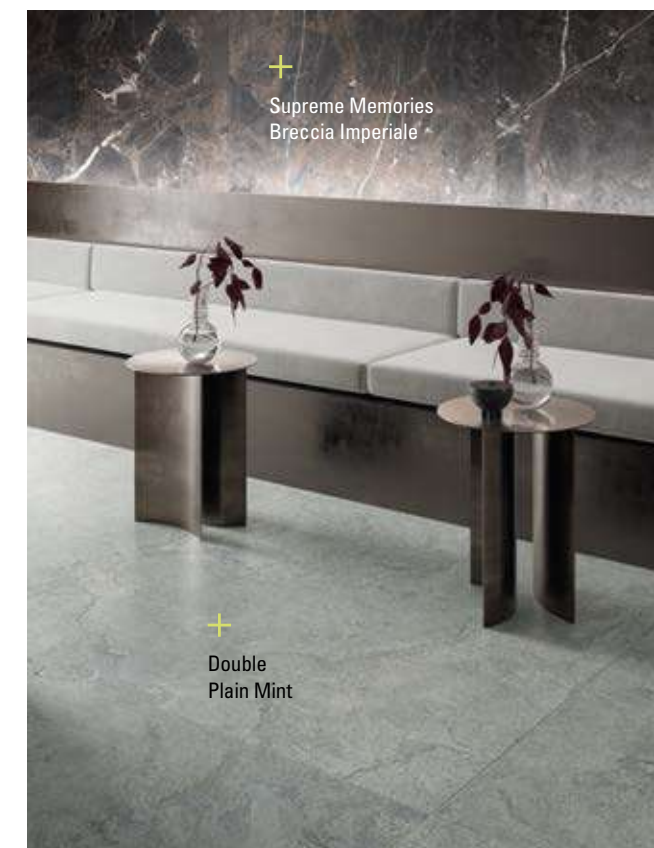
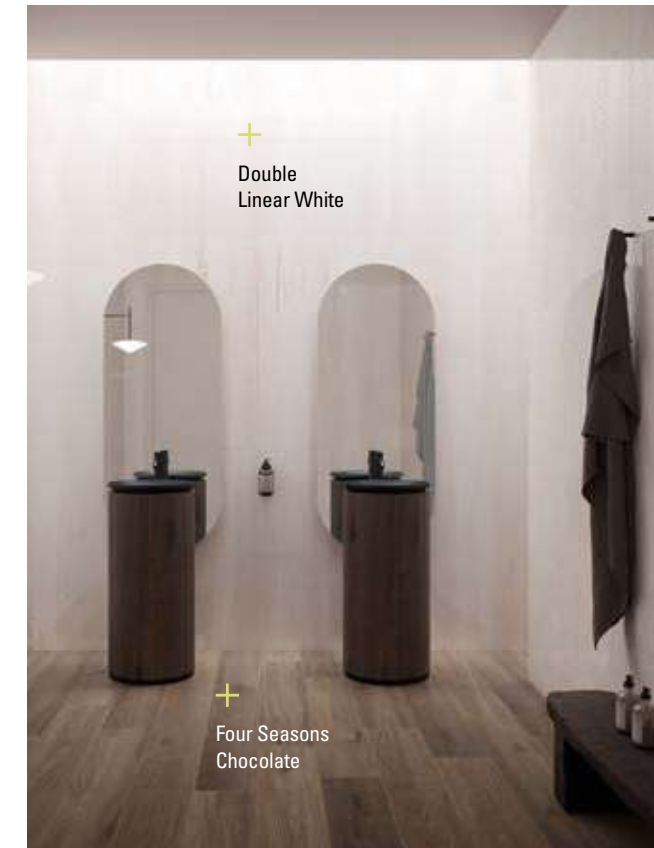
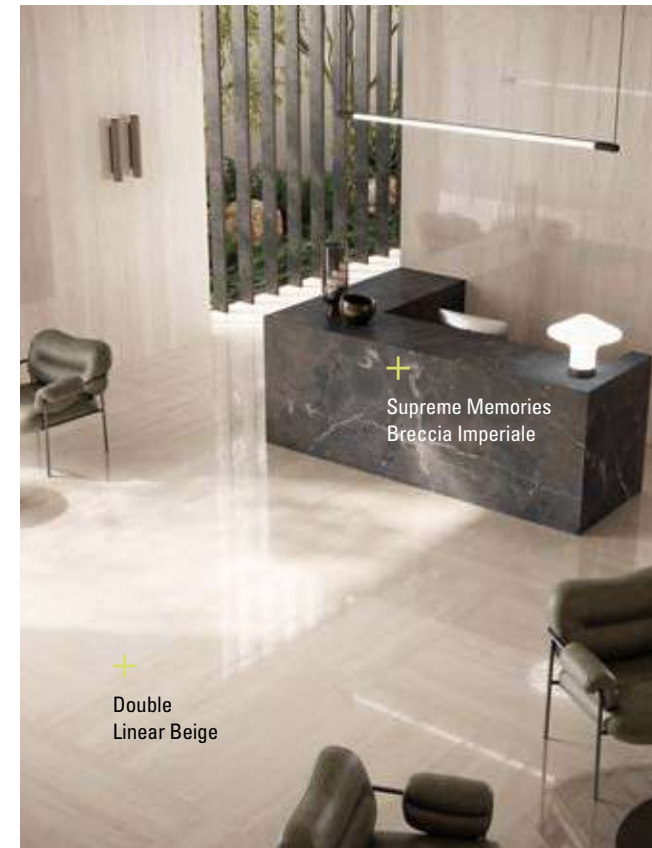

Index

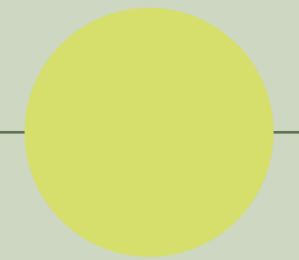

Projects

Marble	Supreme Memories Supreme Treasure Supreme Evo Supreme Classic Navona
Stone	Double Rockin' Blue Savoy Re_Tour Nordik Stone
Wood	Four Seasons Nordik Wood Cozy Flaviker-Dakota Zen
Metal	Rebel
Concrete	Hyper Backstage

Decor & Wall

Art Walls Flow Chrome

Outdoor

X20 - 20 mm	Supreme Memories Double Rockin' Hyper Blue Savoy Still No_w Rebel Nordik Stone Re_Tour Navona Four Seasons Nordik Wood Cozy Flaviker-Dakota
X30 - 30 mm	Backstage Nordik Stone Rebel Navona Flaviker-Dakota

Technical Information



+
Rockin'
Lava
20x120

+
Rockin'
Ice
60x120

Stone

+ Rockin'

Gres porcellanato tutta massa **UGL**

Full body porcelain **UGL**

P. tech FULLBODY**3D** 3D**tech**



Complete Collection

Formati

Sizes

6 mm
120x280 nat

8,5 mm
120x120 nat
60x120 nat/R11
20x120 nat
60x60 nat

20 mm X20
120x120 R11
60x120 R11



Ice



Grey



Lava

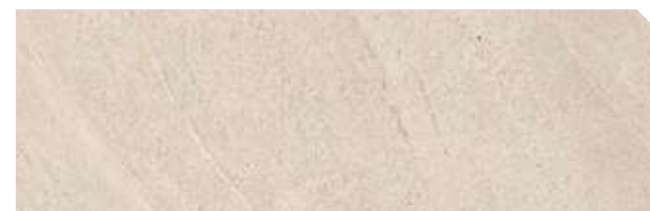

Desert

Index

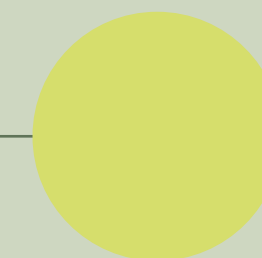

Projects

Marble	Supreme Memories Supreme Treasure Supreme Evo Supreme Classic Navona
Stone	Double Rockin' Blue Savoy Re_Tour Nordik Stone
Wood	Four Seasons Nordik Wood Cozy Flaviker-Dakota Zen
Metal	Rebel
Concrete	Hyper Backstage

Decor & Wall

	Art Walls Flow Chrome
--	-----------------------------

Outdoor

X20 - 20 mm	Supreme Memories Double Rockin' Hyper Blue Savoy Still No_w Rebel Nordik Stone Re_Tour Navona Four Seasons Nordik Wood Cozy Flaviker-Dakota
X30 - 30 mm	Backstage Nordik Stone Rebel Navona Flaviker-Dakota

Technical Information



Calacatta Emerald
163,5x323
MATERIA

Rockin'
Ice
120x120

Stone

Rockin'



Ice Grey Lava Desert

			Ice	Grey	Lava	Desert
6 mm	120x280 48"x112"	NAT RETT.	•	•		•
8,5 mm	120x120 48"x48"	NAT RETT. P. TECH R10 C	•	•	•	•
	60x120 24"x48"	NAT RETT. P. TECH R10 C	•	•	•	•
	20x120 8"x48"	NAT RETT. P. TECH R10 C	•	•	•	•
	60x60 24"x24"	NAT RETT. P. TECH R10 C	•	•	•	•
20 mm	60x120 24"x48"	R11 RETT. P. TECH	•	•	•	•
	120x120 48"x48"	R11 RETT. P. TECH				•
	60x120 24"x48"	R11 RETT. P. TECH		•		•

Index

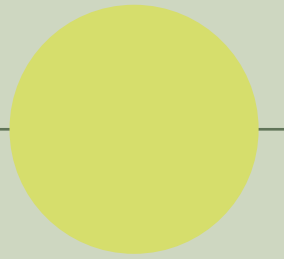

Projects

Marble	Supreme Memories Supreme Treasure Supreme Evo Supreme Classic Navona
Stone	Double Rockin' Blue Savoy Re_Tour Nordik Stone
Wood	Four Seasons Nordik Wood Cozy Flaviker-Dakota Zen
Metal	Rebel
Concrete	Hyper Backstage

Decor & Wall

	Art Walls Flow Chrome
--	-----------------------------

Outdoor

X20 - 20 mm	Supreme Memories Double Rockin' Hyper Blue Savoy Still No_w Rebel Nordik Stone Re_Tour Navona Four Seasons Nordik Wood Cozy Flaviker-Dakota
X30 - 30 mm	Backstage Nordik Stone Rebel Navona Flaviker-Dakota

Technical Information

Ice

6 mm				
120x280	NAT. R.		0010431	M. 102,50
8,5 mm				
120x120	NAT. R.	P.TECH R10 C	0010107	M. 84,50
60x120	NAT. R.	P.TECH R10 C	0010111	M. 64,90
	R11 R.	P.TECH	0010141	M. 64,90
20x120	NAT. R.	P.TECH R10 C	0010115	M. 70,90
60x60	NAT. R.	P.TECH R10 C	0010119	M. 56,50



Grey

6 mm				
120x280	NAT. R.		0010102	M. 102,50
8,5 mm				
120x120	NAT. R.	P.TECH R10 C	0010109	M. 84,50
60x120	NAT. R.	P.TECH R10 C	0010113	M. 64,90
	R11 R.	P.TECH	0010143	M. 64,90
20x120	NAT. R.	P.TECH R10 C	0010117	M. 70,90
60x60	NAT. R.	P.TECH R10 C	0010121	M. 56,50
20 mm X20				
60x120	R11 R.	P.TECH	0010146	M. 87,90



Lava

8,5 mm				
120x120	NAT. R.	P.TECH R10 C	0010110	M. 84,50
60x120	NAT. R.	P.TECH R10 C	0010114	M. 64,90
	R11 R.	P.TECH	0010144	M. 64,90
20x120	NAT. R.	P.TECH R10 C	0010118	M. 70,90
60x60	NAT. R.	P.TECH R10 C	0010122	M. 56,50

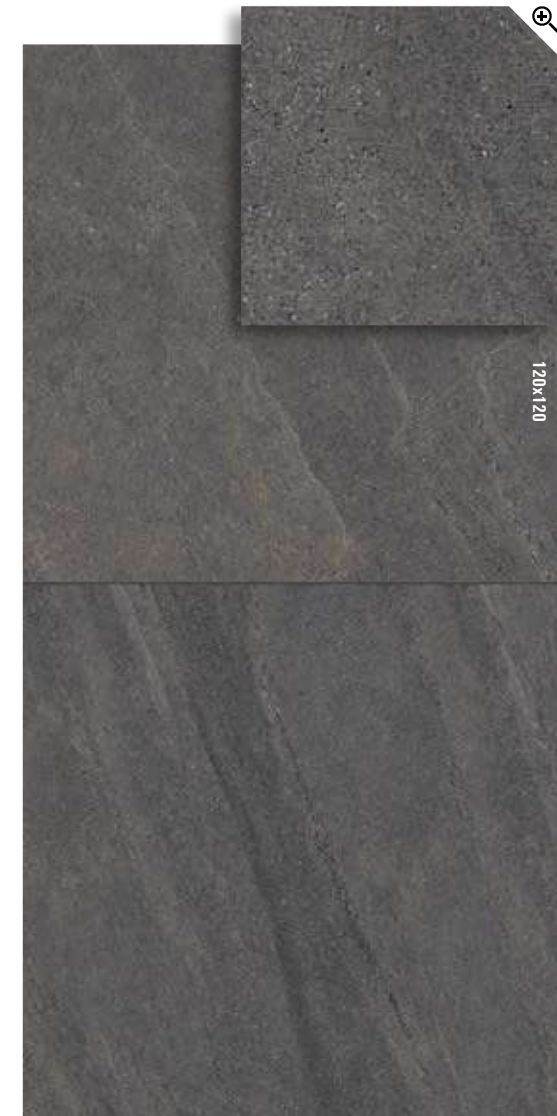

Desert

6 mm				
120x280	NAT. R.		0010101	M. 102,50
8,5 mm				
120x120	NAT. R.	P.TECH R10 C	0010108	M. 84,50
60x120	NAT. R.	P.TECH R10 C	0010112	M. 64,90
	R11 R.	P.TECH	0010142	M. 64,90
20x120	NAT. R.	P.TECH R10 C	0010116	M. 70,90
60x60	NAT. R.	P.TECH R10 C	0010120	M. 56,50
20 mm X20				
120x120	R11 R.	P.TECH	0012901	M. 108,50
60x120	R11 R.	P.TECH	0010145	M. 87,90



Index

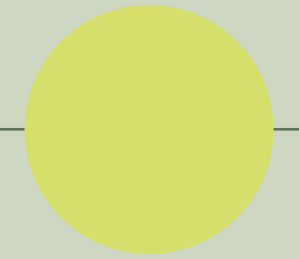

Projects

Marble	Supreme Memories Supreme Treasure Supreme Evo Supreme Classic Navona
Stone	Double Rockin' Blue Savoy Re_Tour Nordik Stone
Wood	Four Seasons Nordik Wood Cozy Flaviker-Dakota Zen
Metal	Rebel
Concrete	Hyper Backstage

Decor & Wall

	Art Walls Flow Chrome
--	-----------------------------

Outdoor

X20 - 20 mm	Supreme Memories Double Rockin' Hyper Blue Savoy Still No_w Rebel Nordik Stone Re_Tour Navona Four Seasons Nordik Wood Cozy Flaviker-Dakota
X30 - 30 mm	Backstage Nordik Stone Rebel Navona Flaviker-Dakota

Technical Information

3D tech



60x120
0010769
ROCKIN' NET ICE 3D TECH
M.84,50 8,5 mm



60x120
0010126
ROCKIN' LOZENGE GREY 3D TECH
M.84,50 8,5 mm



60x120
0010767
ROCKIN' BLAST LAVA 3D TECH
M.84,50 8,5 mm



60x120
0010129
ROCKIN' FLORAL DESERT 3D TECH
M.84,50 8,5 mm

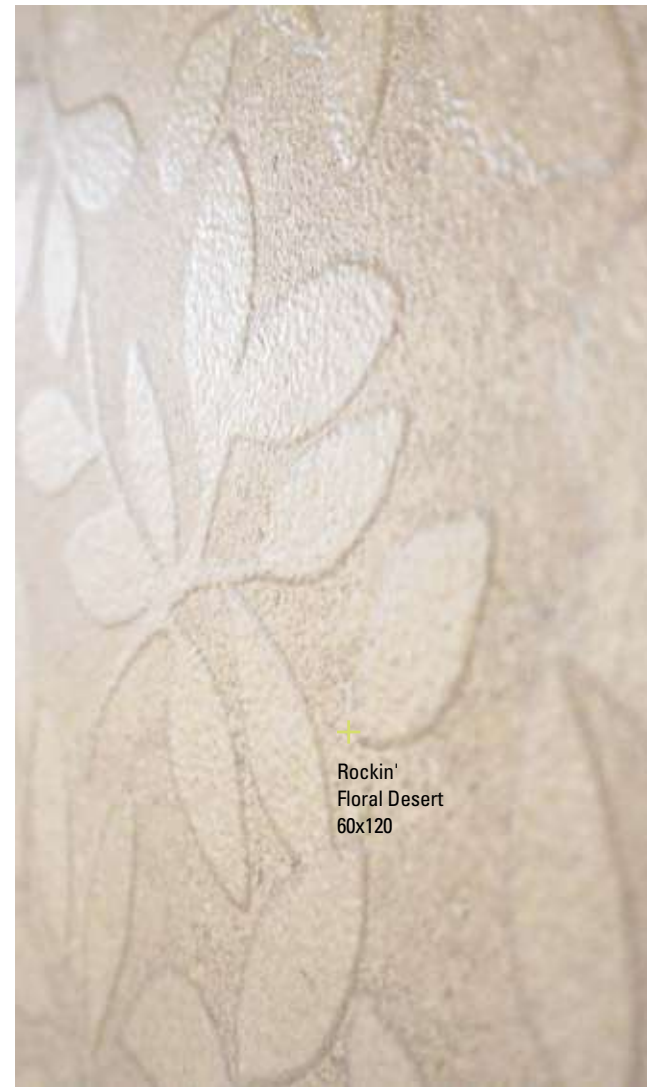

+
Rockin'
Floral Desert
60x120



+
Rockin'
Blast Lava
60x120

La non perfetta continuità di linee, rilievi o motivi grafici tra piastrelle adiacenti è naturale conseguenza del processo produttivo, pertanto non costituisce un vizio del prodotto. / Any variations in graphic designs or textures between adjacent tiles are a natural consequence of the manufacturing process and do not constitute a product defect.

Index

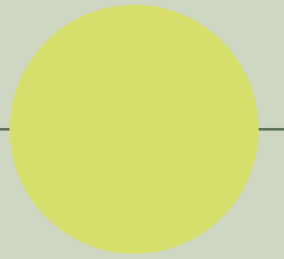

Projects

Marble	Supreme Memories Supreme Treasure Supreme Evo Supreme Classic Navona
Stone	Double Rockin' Blue Savoy Re_Tour Nordik Stone
Wood	Four Seasons Nordik Wood Cozy Flaviker-Dakota Zen
Metal	Rebel
Concrete	Hyper Backstage

Decor & Wall

	Art Walls Flow Chrome
--	-----------------------------

Outdoor

X20 - 20 mm	Supreme Memories Double Rockin' Hyper Blue Savoy Still No_w Rebel Nordik Stone Re_Tour Navona Four Seasons Nordik Wood Cozy Flaviker-Dakota
X30 - 30 mm	Backstage Nordik Stone Rebel Navona Flaviker-Dakota

Technical Information

MATERIA.

Disponibile anche
Available also

	Ice	Grey	Lava	Desert	
12 mm					
163,5x323 NAT	-	-	-	0010805	
FULLBODY3D					
20 mm					
163,5x323 NAT	-	-	-	0010806	
FULLBODY3D					



Decor
e Pezzi Speciali
Decors
and Special Trims

	Ice	Grey	Lava	Desert	
Mosaico Sticks 30x30 T14 8,5 mm	NAT. RETT.	0010436	0010438	0010439	0010437 M. 119,50
Mosaico 30x30 T36 8,5 mm	NAT. RETT.	0010432	0010434	0010435	0010433 M. 119,50
Battiscopa 5,5x120 8,5 mm	NAT. RETT.	0010440	0010442	0010443	0010441 P. 11,50
Gradone Top 32x120x4,5x2 8,5 mm	NAT. RETT.	0010444	0010446	0010447	0010445 P. 194,50
Angolare Top SX 32x120x4,5x2 8,5 mm	NAT. RETT.	0010448	0010450	0010451	0010449 P. 225,50
Angolare Top DX 32x120x4,5x2 8,5 mm	NAT. RETT.	0010452	0010454	0010455	0010453 P. 225,50



MATITE ALLUMINIO - ALUMINIUM STRIPS

Articoli realizzati in alluminio anodizzato per l'uso a parete, adatti a raccordare piastrelle di diverso spessore (8,5/7/6 mm). Avvertenze per la posa e la pulizia all'interno delle confezioni o sul sito Flaviker.
Anodized Aluminium strips for use between wall tiles of different thicknesses (8,5/7/6 mm). Instructions for installation and cleaning included in the box or on flaviker website.

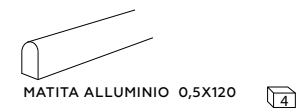

Parte superiore arrotondata. Rounded top.
MATITA ALLUMINIO
000086 P. 24,50

Parte superiore arrotondata e colorata con resine acriliche.
Rounded top colored with acrylic resins.

MATITA ALLUM. ORO
0008535 P. 32,50

MATITA ALLUM. RAME SCURO
0008534 P. 32,50

MATITA ALLUM. WHITE
000087 P. 32,50

MATITA ALLUM. TERRACOTTA
0008530 P. 32,50

MATITA ALLUM. BLU
0008532 P. 32,50

MATITA ALLUM. VERDE
0008531 P. 40,50

MATITA ALLUM. ARDESIA
0008533 P. 32,50

MATITA ALLUM. BLACK
000088 P. 32,50

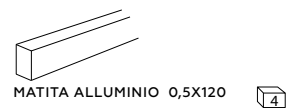

Parte superiore piatta colorata in bagno galvanico.
Flat top colored in galvanic bath.

MATITA ALLUM. BRONZO
0000557 P. 40,50

MATITA ALLUM. RAME
0000556 P. 40,50

GRES PORCELLANATO TUTTA MASSA
FULL BODY PORCELAIN

CLASSIFICAZIONE SECONDO NORME EN 14411 (ISO 13006) ALLEGATO G GRUPPO BIa UGL
SURFACE CLASSIFICATION IN ACCORDANCE WITH EN 14411 (ISO 13006) ANNEX G GROUP BIa UGL



PROPRIETÀ FISICO-CHIMICHE PHYSICAL-CHEMICAL PROPERTIES	NORMA NORM	VALORE PRESCRITTO DALLE NORME VALUE PRESCRIBED FROM THE NORMS	* VAL. / VALUE FLAVIKER NAT.	* VAL. / VALUE FLAVIKER NAT. P.TECH	* VAL. / VALUE FLAVIKER R11 P.TECH
	B.C.R.A. C.A.	a PERICOLOSA - DANGEROUSLY SLIPPERY 0,20 < μ < 0,39 SCIVOLosità ECCESSIVA - EXCESSIVELY SLIPPERY 0,40 < μ < 0,74 ATTRITO SODDISFACENTE - SATISFACTORY GRIP μ 0,75 ATTRITO ECCELLENTE - EXCELLENT GRIP	> 0,40	> 0,40	> 0,40
	B.C.R.A. G.B.		> 0,40	> 0,40	> 0,40
RESISTENZA ALLO SCIVOLAMENTO SLIP RESISTANCE	ASTM C 1028 (S.C.O.F.)	SLIP RESISTANT (> 0,60)	> 0,60 DRY > 0,60 WET	> 0,60 DRY > 0,60 WET	> 0,60 DRY > 0,60 WET
	DIN 51130	IN FUNZIONE DELL'AMBIENTE O DELLA ZONA DI LAVORO BASING ON THE ENVIRONMENT OR THE WORKING AREA	R10	R10	R11
	DIN 51097	-	A+B	A+B+C	A+B+C
	ANSI A 137-1:2012 (D.C.O.F.)	> 0,42	> 0,42	> 0,42	> 0,42
	AS/NZS 4586:2013	SRV : 35 - 44	-	P3 WET	P4 WET
	BS 7976 - 2:2002	> 36	-	+36 WET	+36 WET

*Valori medi di produzione / Average production values

Index

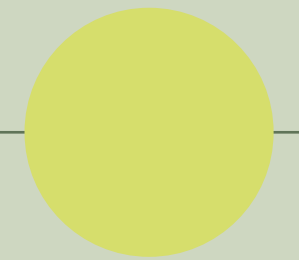

Projects

Marble	Supreme Memories Supreme Treasure Supreme Evo Supreme Classic Navona
Stone	Double Rockin' Blue Savoy Re_Tour Nordik Stone
Wood	Four Seasons Nordik Wood Cozy Flaviker-Dakota Zen
Metal	Rebel
Concrete	Hyper Backstage

Decor & Wall

Art Walls Flow Chrome

Outdoor

X20 - 20 mm	Supreme Memories Double Rockin' Hyper Blue Savoy Still No_w Rebel Nordik Stone Re_Tour Navona Four Seasons Nordik Wood Cozy Flaviker-Dakota
X30 - 30 mm	Backstage Nordik Stone Rebel Navona Flaviker-Dakota

Technical Information

Multiple Sensations

L'Ufficio Stile Flaviker ha costruito una materioteca in grado di dare vita a molteplici combinazioni. Qui trovi gli abbinamenti più interessanti realizzabili a partire da ciascun colore della gamma Rockin'.

Scopri anche i progetti "mix&match" studiati per questa collezione all'interno dell'ambiente bagno.

The Flaviker Style Department has assembled a collection of materials that can be used in many different combinations. Here you'll find the most interesting combinations that can be created using each colour in the Rockin' range.

You'll also discover mix&match solutions designed specifically for use of this collection in the bathroom.

BEST
BATHROOM
ROCKIN'



Chrome



Index

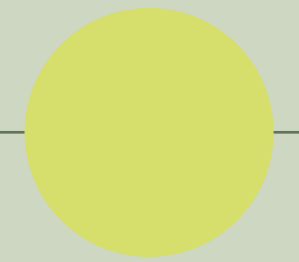

Projects

Marble	Supreme Memories Supreme Treasure Supreme Evo Supreme Classic Navona
Stone	Double Rockin' Blue Savoy Re_Tour Nordik Stone
Wood	Four Seasons Nordik Wood Cozy Flaviker-Dakota Zen
Metal	Rebel
Concrete	Hyper Backstage

Decor & Wall

Art Walls Flow Chrome

Outdoor

X20 - 20 mm	Supreme Memories Double Rockin' Hyper Blue Savoy Still No_w Rebel Nordik Stone Re_Tour Navona Four Seasons Nordik Wood Cozy Flaviker-Dakota
X30 - 30 mm	Backstage Nordik Stone Rebel Navona Flaviker-Dakota

Technical Information



+
Blue Savoy
Grey
120x120

Stone

+ Blue Savoy

Gres porcellanato tutta massa **UGL**
Full body porcelain **UGL**

P. tech



Complete Collection

Formati

Sizes

6 mm
160x320 nat/lux
120x280 nat

8,5 mm
120x120 nat
60x120 nat/R11
30x60 nat
10x60 nat

20 mm X20
120x120 R11
60x120 R11



Blue



Moon



Graphite



Grey

Index

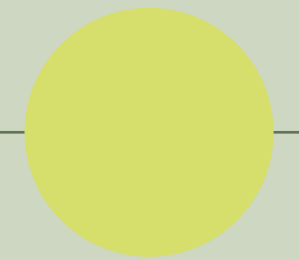

Projects

Marble	Supreme Memories Supreme Treasure Supreme Evo Supreme Classic Navona
Stone	Double Rockin' Blue Savoy Re_Tour Nordik Stone
Wood	Four Seasons Nordik Wood Cozy Flaviker-Dakota Zen
Metal	Rebel
Concrete	Hyper Backstage

Decor & Wall

	Art Walls Flow Chrome
--	-----------------------------

Outdoor

X20 - 20 mm	Supreme Memories Double Rockin' Hyper Blue Savoy Still No_w Rebel Nordik Stone Re_Tour Navona Four Seasons Nordik Wood Cozy Flaviker-Dakota
X30 - 30 mm	Backstage Nordik Stone Rebel Navona Flaviker-Dakota

Technical Information



Classic Marquinia
Lux 12mm
MATERIA

Blue Savoy
Moon
120x120

Stone

Blue Savoy



Blue Moon Graphite Grey

Thickness	Size	Finish	Blue	Moon	Graphite	Grey
6 mm	160x320 63"x126"	NAT RETT.	•			
	160x320 63"x126"	LUX RETT.	•			
	120x280 48"x112"	NAT RETT.	•	•		
8,5 mm	120x120 48"x48"	NAT RETT. P. TECH R10 C	•	•	•	•
	60x120 24"x48"	NAT RETT. P. TECH R10 C	•	•	•	•
	60x60 24"x24"	NAT RETT. P. TECH R10 C	•	•	•	•
	60x60 24"x24"	R11 RETT. P. TECH	•	•	•	•
	30x60 12"x24"	NAT RETT. P. TECH R10 C	•	•	•	•
	10x60 4"x24"	NAT RETT. P. TECH R10 C	•	•	•	•
20 mm	120x120 48"x48"	R11 RETT. P. TECH		•		•
	60x120 24"x48"	R11 RETT. P. TECH		•	•	•

Index

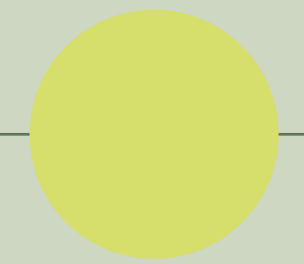

Projects

Material	Projects
Marble	Supreme Memories Supreme Treasure Supreme Evo Supreme Classic Navona
Stone	Double Rockin' Blue Savoy Re_Tour Nordik Stone
Wood	Four Seasons Nordik Wood Cozy Flaviker-Dakota Zen
Metal	Rebel
Concrete	Hyper Backstage

Decor & Wall

Art Walls Flow Chrome

Outdoor

Thickness	Projects
X20 - 20 mm	Supreme Memories Double Rockin' Hyper Blue Savoy Still No_w Rebel Nordik Stone Re_Tour Navona Four Seasons Nordik Wood Cozy Flaviker-Dakota
X30 - 30 mm	Backstage Nordik Stone Rebel Navona Flaviker-Dakota

Technical Information

Blue

6 mm				
160x320	NAT. R.		0005953	M. 126,50
	LUX. R.		0005955	M. 151,50
120x280 *	NAT. R.		0008658	M. 101,90

8,5 mm				
120x120	NAT. R.	P.TECH R10 C	0005978	M. 80,50
60x120	NAT. R.	P.TECH R10 C	0005981	M. 61,90
60x60	NAT. R.	P.TECH R10 C	0006718	M. 51,50
	R11 R.	P.TECH	0006724	M. 51,50
30x60	NAT. R.	P.TECH R10 C	0007792	M. 46,90
10x60	NAT. R.	P.TECH R10 C	0007796	M. 64,50



120x280

Moon

6 mm				
120x280 *	NAT. R.		0008659	M. 101,90

8,5 mm				
120x120	NAT. R.	P.TECH R10 C	0005976	M. 80,50
60x120	NAT. R.	P.TECH R10 C	0005979	M. 61,90
60x60	NAT. R.	P.TECH R10 C	0006716	M. 51,50
	R11 R.	P.TECH	0006722	M. 51,50
30x60	NAT. R.	P.TECH R10 C	0007790	M. 46,90
10x60	NAT. R.	P.TECH R10 C	0007794	M. 64,50

20 mm				
	X20			
120x120	R11 R.	P.TECH	0012900	M. 108,50
60x120	R11 R.	P.TECH	0008358	M. 87,90



120x280

Graphite

8,5 mm				
120x120	NAT. R.	P.TECH R10 C	0007821	M. 80,50
60x120	NAT. R.	P.TECH R10 C	0007822	M. 61,90
60x60	NAT. R.	P.TECH R10 C	0007789	M. 51,50
	R11 R.	P.TECH	0007799	M. 51,50
30x60	NAT. R.	P.TECH R10 C	0007793	M. 46,90
10x60	NAT. R.	P.TECH R10 C	0007797	M. 64,50

20 mm				
	X20			
120x120	R11 R.	P.TECH	0006339	M. 64,50



120x120

Grey

8,5 mm				
120x120	NAT. R.	P.TECH R10 C	0005977	M. 80,50
60x120	NAT. R.	P.TECH R10 C	0005980	M. 61,90
60x60	NAT. R.	P.TECH R10 C	0006717	M. 51,50
	R11 R.	P.TECH	0006723	M. 51,50
30x60	NAT. R.	P.TECH R10 C	0007791	M. 46,90
10x60	NAT. R.	P.TECH R10 C	0007795	M. 64,50

20 mm				
	X20			
120x120	R11 R.	P.TECH	0012899	M. 108,50
60x120	R11 R.	P.TECH	0006338	M. 87,90



60x120

Index

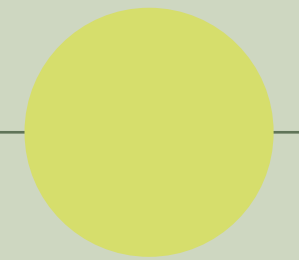

Projects

Marble	Supreme Memories Supreme Treasure Supreme Evo Supreme Classic Navona
Stone	Double Rockin' Blue Savoy Re_Tour Nordik Stone
Wood	Four Seasons Nordik Wood Cozy Flaviker-Dakota Zen
Metal	Rebel
Concrete	Hyper Backstage

Decor & Wall

	Art Walls Flow Chrome
--	-----------------------------

Outdoor

X20 - 20 mm	Supreme Memories Double Rockin' Hyper Blue Savoy Still No_w Rebel Nordik Stone Re_Tour Navona Four Seasons Nordik Wood Cozy Flaviker-Dakota
X30 - 30 mm	Backstage Nordik Stone Rebel Navona Flaviker-Dakota

Technical Information

MATERIA.

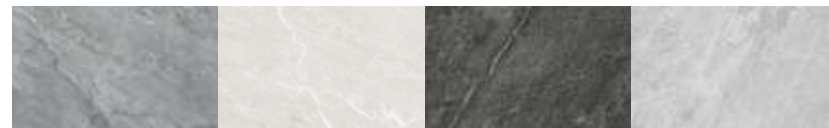

Disponibile anche Available also		Blue	Moon	Graphite	Grey
6 mm	NAT	0005952	-	-	-
163,5x323	LUX	0006239	-	-	-
12 mm	NAT	0006290	0014644	-	-
163,5x323	LUX	0006289	-	-	-
20 mm	NAT	0008033	0014931	-	-
163,5x323	LUX	0008357	-	-	-



120x120
0007824
TEX GRAPHITE NAT RETT. P.TECH R10 C
M. 89,50

60x120
0006337
TEX GRAPHITE NAT RETT. P.TECH R10 C
M. 71,90

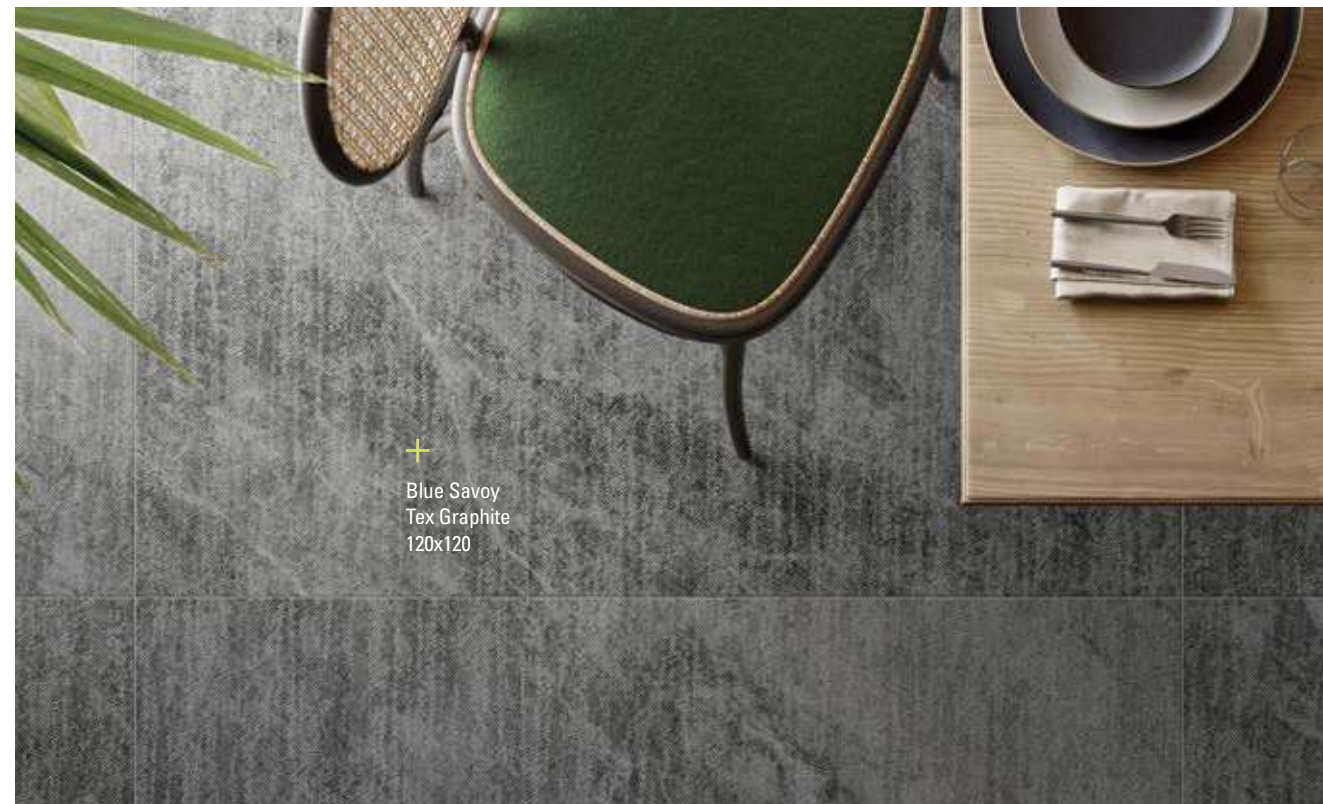

+
Blue Savoy
Tex Graphite
120x120

MATITE ALLUMINIO - ALUMINIUM STRIPS

Articoli realizzati in alluminio anodizzato per l'uso a parete, adatti a raccordare piastrelle di diverso spessore (8,5/7/6 mm). Avvertenze per la posa e la pulizia all'interno delle confezioni o sul sito Flaviker.
Anodized Aluminium strips for use between wall tiles of different thicknesses (8,5/7/6 mm). Instructions for installation and cleaning included in the box or on flaviker website.

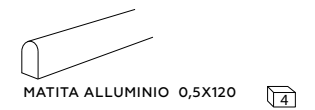

Parte superiore arrotondata. Rounded top.
MATITA ALLUMINIO
0000086 P. 24,50

Parte superiore arrotondata e colorata con resine acriliche.
Rounded top colored with acrylic resins.

 MATITA ALLUM. ORO
0008535 P. 32,50

 MATITA ALLUM. RAME SCURO
0008534 P. 32,50

 MATITA ALLUM. WHITE
0000087 P. 32,50

 MATITA ALLUM. TERRACOTTA
0008530 P. 32,50

 MATITA ALLUM. BLU
0008532 P. 32,50

 MATITA ALLUM. VERDE
0008531 P. 32,50

 MATITA ALLUM. ARDESIA
0008533 P. 32,50

 MATITA ALLUM. BLACK
0000088 P. 32,50

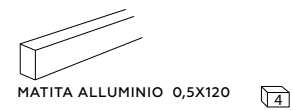

Parte superiore piatta colorata in bagno galvanico
Flat top colored in galvanic bath.

 MATITA ALLUM. BRONZO
0000557 P. 40,50

 MATITA ALLUM. RAME
0000556 P. 40,50

Index

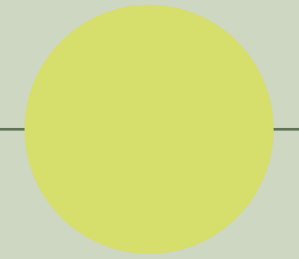

Projects

Marble	Supreme Memories Supreme Treasure Supreme Evo Supreme Classic Navona
Stone	Double Rockin' Blue Savoy Re_Tour Nordik Stone
Wood	Four Seasons Nordik Wood Cozy Flaviker-Dakota Zen
Metal	Rebel
Concrete	Hyper Backstage

Decor & Wall

	Art Walls Flow Chrome
--	-----------------------------

Outdoor

X20 - 20 mm	Supreme Memories Double Rockin' Hyper Blue Savoy Still No_w Rebel Nordik Stone Re_Tour Navona Four Seasons Nordik Wood Cozy Flaviker-Dakota
X30 - 30 mm	Backstage Nordik Stone Rebel Navona Flaviker-Dakota

Technical Information

Schemi di posa
Installation patterns

1.1 2 COLORI

60x60 75% 10x60 25%

2.1 2 COLORI

10x60 75% 10x60 25%

2.2 2 COLORI

10x60 50% 10x60 50%

2.3 4 COLORI

10x60 25% 10x60 25% 10x60 25% 10x60 25%

3.1 3 COLORI

10x60 33,3% 10x60 33,3% 10x60 33,3%

4.1 2 COLORI

60x120 86% 10x60 14%

Decor
e Pezzi Speciali
Decors
and Special Trims



		BLUE	MOON	GRAPHITE	GREY	
8,5 mm	Mosaico 30x30	NAT RETT. 0007942	0007940	0007943	0007941	M. 119,50
8,5 mm	Battiscopa 5,5x60	NAT RETT. 0006859	0006857	0007800	0006858	P. 7,90
8,5 mm	Battiscopa 5,5x120	NAT RETT. 0008585	0008583	0008586	0008584	P. 11,50
8,5 mm	Gradone Top 32x120x4,5x2	NAT RETT. 0006862	0006860	0007801	0006861	P. 194,50
8,5 mm	Angolare Top SX 32x120x4,5x2	NAT RETT. 0006865	0006863	0007802	0006864	P. 225,50
8,5 mm	Angolare Top DX 32x120x4,5x2	NAT RETT. 0006868	0006866	0007803	0006867	P. 225,50

GRES PORCELLANATO TUTTA MASSA
FULL BODY PORCELAIN

CLASSIFICAZIONE SECONDO NORME EN 14411 (ISO 13006) ALLEGATO G GRUPPO BIa UGL
CLASSIFICATION IN ACCORDANCE WITH EN 14411 (ISO 13006) ANNEX G GROUP BIa UGL



PROPRIETÀ FISICO-CHIMICHE PHYSICAL-CHEMICAL PROPERTIES	NORMA NORM	VALORE PRESCRITTO DALLE NORME VALUE PRESCRIBED FROM THE NORMS	* VAL. / VALUE FLAVIKER NAT.	* VAL. / VALUE FLAVIKER NAT. P.TECH	* VAL. / VALUE FLAVIKER R11 P.TECH
	B.C.R.A. C.A.	μ 0,19 SCIVOLosità PERICOLOSA - DANGEROUSLY SLIPPERY 0,20 < μ < 0,39 SCIVOLosità ECCESSIVA - EXCESSIVELY SLIPPERY 0,40 < μ < 0,74 ATRIBITO SODDISFACENTE - SATISFACTORY GRIP μ 0,75 ATRIBITO ECCELLENTE - EXCELLENT GRIP	> 0,40	> 0,40	> 0,40
	B.C.R.A. G.B.		> 0,40	> 0,40	> 0,40
RESISTENZA ALLO SCIVOLAMENTO SLIP RESISTANCE	ASTM C 1028 (S.C.O.F.)	SLIP RESISTANT (> 0,60)	> 0,60 DRY > 0,60 WET	> 0,60 DRY > 0,60 WET	> 0,60 DRY > 0,60 WET
	DIN 51130	IN FUNZIONE DELL'AMBIENTE O DELLA ZONA DI LAVORO BASING ON THE ENVIRONMENT OR THE WORKING AREA	R10	R10	R11
	DIN 51097	-	A+B	A+B+C	A+B+C
	ANSI A 137-1:2012 (D.C.O.F.)	> 0,42	> 0,42	> 0,42	> 0,42
	AS/NZS 4586:2013	SRV : 35 - 44	-	P3 WET	P4 WET
	BS 7976 - 2:2002	> 36	-	+ 36 WET	+ 36 WET

*Valori medi di produzione / Average production values

Index

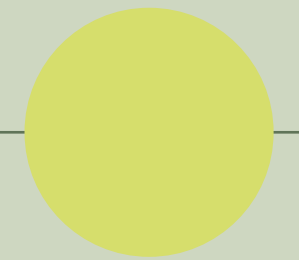

Projects

Marble	Supreme Memories Supreme Treasure Supreme Evo Supreme Classic Navona
Stone	Double Rockin' Blue Savoy Re_Tour Nordik Stone
Wood	Four Seasons Nordik Wood Cozy Flaviker-Dakota Zen
Metal	Rebel
Concrete	Hyper Backstage

Decor & Wall

Art Walls Flow Chrome

Outdoor

X20 - 20 mm	Supreme Memories Double Rockin' Hyper Blue Savoy Still No_w Rebel Nordik Stone Re_Tour Navona Four Seasons Nordik Wood Cozy Flaviker-Dakota
X30 - 30 mm	Backstage Nordik Stone Rebel Navona Flaviker-Dakota

Technical Information

Multiple Sensations

L'Ufficio Stile Flaviker ha costruito una materioteca in grado di dare vita a molteplici combinazioni. Qui trovi gli abbinamenti più interessanti realizzabili a partire da ciascun colore della gamma Blue Savoy.

Scopri anche i progetti "mix&match" studiati per questa collezione all'interno dell'ambiente bagno.

The Flaviker Style Department has assembled a collection of materials that can be used in many different combinations. Here you'll find the most interesting combinations that can be created using each colour in the Blue Savoy range.

You'll also discover mix&match solutions designed specifically for use of this collection in the bathroom.

BEST
BATHROOM
BLUE
SAVOY



Blue Savoy



Blue



Moon



Graphite



Grey

Rebel

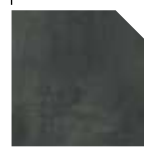

NIGHT



SILVER



WHITE



NIGHT

Chrome



WHITE



BLACK

Supreme Treasure/Evo



LASA SAPPHIRE



CLASSIC MARQUINIA



GREYLAC PLATINUM



STAT. SUPERIOR

Four Seasons



HONEY



CHOCOLATE



HONEY



HONEY

Nordik Wood



GOLD



GOLD



BEIGE



BEIGE



Index

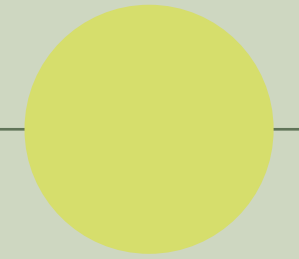

Projects

Marble	Supreme Memories Supreme Treasure Supreme Evo Supreme Classic Navona
Stone	Double Rockin' Blue Savoy Re_Tour Nordik Stone
Wood	Four Seasons Nordik Wood Cozy Flaviker-Dakota Zen
Metal	Rebel
Concrete	Hyper Backstage

Decor & Wall

	Art Walls Flow Chrome
--	-----------------------------

Outdoor

X20 - 20 mm	Supreme Memories Double Rockin' Hyper Blue Savoy Still No_w Rebel Nordik Stone Re_Tour Navona Four Seasons Nordik Wood Cozy Flaviker-Dakota
X30 - 30 mm	Backstage Nordik Stone Rebel Navona Flaviker-Dakota

Technical Information



Stone

+
Re_Tour

Gres porcellanato tutta massa UGL
Full body porcelain UGL



Complete Collection

Formati

Sizes

6 mm		
120x280	nat	
8,5 mm		
120x120	nat	
60x120	nat	
90x90	nat	
60x60	nat/R11	
20 mm X20		
60x90	R11	



Ivory



Fog



Rope



Mud

+
Re_Tour
Mud
90x90

Index

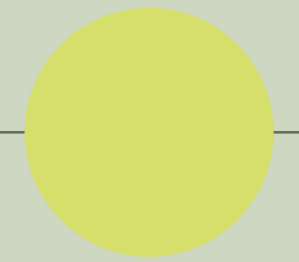

Projects

Marble	Supreme Memories Supreme Treasure Supreme Evo Supreme Classic Navona
Stone	Double Rockin' Blue Savoy Re_Tour Nordik Stone
Wood	Four Seasons Nordik Wood Cozy Flaviker-Dakota Zen
Metal	Rebel
Concrete	Hyper Backstage

Decor & Wall

	Art Walls Flow Chrome
--	-----------------------------

Outdoor

X20 - 20 mm	Supreme Memories Double Rockin' Hyper Blue Savoy Still No_w Rebel Nordik Stone Re_Tour Navona Four Seasons Nordik Wood Cozy Flaviker-Dakota
X30 - 30 mm	Backstage Nordik Stone Rebel Navona Flaviker-Dakota

Technical Information



+
Re_Tour
Fog
120x120

Stone

Re_Tour



Ivory Fog Rope Mud

6 mm	120x280 48"x112"	NAT RETT.	•	•		
8,5 mm	120x120 48"x48"	NAT RETT.	•	•	•	•
	60x120 24"x48"	NAT RETT.	•	•	•	•
	90x90 36"x36"	NAT RETT.	•	•	•	•
	60x60 24"x24"	NAT RETT.	•	•	•	•
20 mm	60x60 24"x24"	R11 RETT. P3	•	•	•	•
	60x90 24"x36"	R11 RETT. P.TECH		•	•	

Index

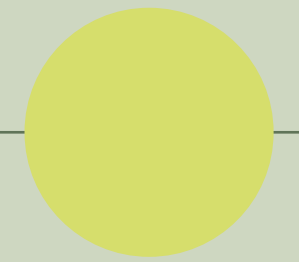

Projects

Marble	Supreme Memories Supreme Treasure Supreme Evo Supreme Classic Navona
Stone	Double Rockin' Blue Savoy Re_Tour Nordik Stone
Wood	Four Seasons Nordik Wood Cozy Flaviker-Dakota Zen
Metal	Rebel
Concrete	Hyper Backstage

Decor & Wall

	Art Walls Flow Chrome
--	-----------------------------

Outdoor

X20 - 20 mm	Supreme Memories Double Rockin' Hyper Blue Savoy Still No_w Rebel Nordik Stone Re_Tour Navona Four Seasons Nordik Wood Cozy Flaviker-Dakota
X30 - 30 mm	Backstage Nordik Stone Rebel Navona Flaviker-Dakota

Technical Information

Ivory

6 mm				
120x280	NAT. R.	0008186	M.	101,90
8,5 mm				
120x120	NAT. R.	0005996	M.	80,50
60x120	NAT. R.	0006000	M.	61,90
90x90	NAT. R.	0006678	M.	61,90
60x60	NAT. R.	0006010	M.	51,50
60x60	R11 R.	P3	0006396	M. 51,50



120x280

Fog

6 mm				
120x280	NAT. R.	0008187	M.	101,90
8,5 mm				
120x120	NAT. R.	0005997	M.	80,50
60x120	NAT. R.	0006001	M.	61,90
90x90	NAT. R.	0006679	M.	61,90
60x60	NAT. R.	0006011	M.	51,50
60x60	R11 R.	P3	0006397	M. 51,50
20 mm				
60x90	R11 R.	P.TECH	0007178	M. 83,50



120x280

Rope

8,5 mm				
120x120	NAT. R.	0005998	M.	80,50
60x120	NAT. R.	0006002	M.	61,90
90x90	NAT. R.	0006680	M.	61,90
60x60	NAT. R.	0006012	M.	51,50
60x60	R11 R.	P3	0006398	M. 51,50
20 mm				
60x90	R11 R.	P.TECH	0007177	M. 83,50



60x120

Mud

8,5 mm				
120x120	NAT. R.	0005999	M.	80,50
60x120	NAT. R.	0006003	M.	61,90
90x90	NAT. R.	0006681	M.	61,90
60x60	NAT. R.	0006013	M.	51,50
60x60	R11 R.	P3	0006399	M. 51,50



120x120

Index



Projects

Marble	Supreme Memories Supreme Treasure Supreme Evo Supreme Classic Navona
Stone	Double Rockin' Blue Savoy Re_Tour Nordik Stone
Wood	Four Seasons Nordik Wood Cozy Flaviker-Dakota Zen
Metal	Rebel
Concrete	Hyper Backstage

Decor & Wall

	Art Walls Flow Chrome
--	-----------------------------

Outdoor

X20 - 20 mm	Supreme Memories Double Rockin' Hyper Blue Savoy Still No_w Rebel Nordik Stone Re_Tour Navona Four Seasons Nordik Wood Cozy Flaviker-Dakota
X30 - 30 mm	Backstage Nordik Stone Rebel Navona Flaviker-Dakota

Technical Information

MATERIA.

Disponibile anche
Available also



Ivory Fog Rope Mud

12 mm					
163,5x323	NAT	-	0008472	-	-
FULLBODY3D					
20 mm					
163,5x323	NAT	-	0008463	-	-
FULLBODY3D					



60x120
0006005
DECOR MIX RETT.
M. 71,90

8,5 mm



60x60
0006429
DECOR MIX RETT.
M. 59,50

8,5 mm

Articolo composto da pattern grafici diversi che non prevedono agganci tra loro e miscelati in modo casuale in fase di inscatolamento. Non si garantisce pertanto la presenza costante di tutti i soggetti all'interno delle confezioni. / This article comes in several different versions with unconnected patterns that are mixed randomly at the time of packaging. There is therefore no guarantee that all patterns will be present in any individual box.

Mix Floor_schemi di posa
Mix Floor_Installation patterns

1.1

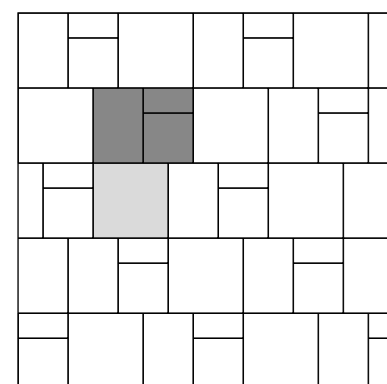

90x90 **42,9 %**
60x90 MIX FLOOR **57,1%**

2.1

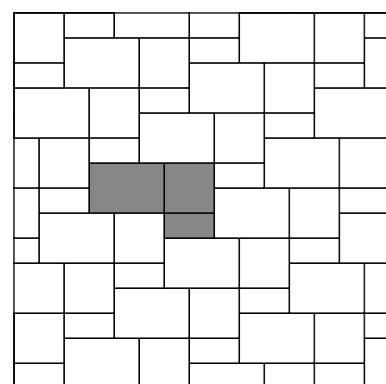

60x90 MIX FLOOR **100%**

Decor
e Pezzi Speciali
Decors
and Special Trims



Ivory Fog Rope Mud

	Mix Floor 60x90 1pz 60x60 1pz 30x60 1pz	NAT RETT.	0006682	0006683	0006684	0006685	M. 84,50
	8,5 mm						
	Battiscopa 5,5x90	NAT RETT.	0006837	0006838	0006839	0006840	P. 9,90
	8,5 mm						
	Battiscopa 5,5x120	NAT RETT.	0008579	0008580	0008581	0008582	P. 11,50
	8,5 mm						
	Gradone Top 32x120x4,5x2	NAT RETT.	0006841	0006842	0006843	0006844	P. 194,50
	8,5 mm						
	Angolare Top SX 32x120x4,5x2	NAT RETT.	0006845	0006846	0006847	0006848	P. 225,50
	8,5 mm						
	Angolare Top DX 32x120x4,5x2	NAT RETT.	0006849	0006850	0006851	0006852	P. 225,50
	8,5 mm						

GRES PORCELLANATO TUTTA MASSA
FULL BODY PORCELAIN

CLASSIFICAZIONE SECONDO NORME EN 14411 (ISO 13006) ALLEGATO G GRUPPO BIa UGL
CLASSIFICATION IN ACCORDANCE WITH EN 14411 (ISO 13006) ANNEX G GROUP BIa UGL



PROPRIETÀ FISICO-CHIMICHE PHYSICAL-CHEMICAL PROPERTIES	NORMA NORM	VALORE PRESCRITTO DALLE NORME VALUE PRESCRIBED FROM THE NORMS	* VAL. / VALUE FLAVIKER NAT.	* VAL. / VALUE FLAVIKER R11
RESISTENZA ALLO SCIVOLAMENTO SLIP RESISTANCE	B.C.R.A. C.A.	μ 0,19 SCIVOLOSITÀ PERICOLOSA - DANGEROUSLY SLIPPERY $0,20 < \mu < 0,39$ SCIVOLOSITÀ ECCESSIVA - EXCESSIVELY SLIPPERY $0,40 < \mu < 0,74$ ATTRITO SODDISFACENTE - SATISFACTORY GRIP μ 0,75 ATTRITO ECCELLENTE - EXCELLENT GRIP	> 0,40	> 0,40
	B.C.R.A. G.B.		> 0,40	> 0,40
	ASTM C 1028 (S.C.O.F.)	SLIP RESISTANT (> 0,60)	> 0,60 DRY > 0,60 WET	> 0,60 DRY > 0,60 WET
	DIN 51130	IN FUNZIONE DELL'AMBIENTE O DELLA ZONA DI LAVORO BASING ON THE ENVIRONMENT OR THE WORKING AREA	R10	R11
	DIN 51097	-	A+B	A+B+C
	ANSI A 137-1:2012 (D.C.O.F.)	> 0,42	> 0,42	> 0,42

*Valori medi di produzione / Average production values



Projects

Marble	Supreme Memories Supreme Treasure Supreme Evo Supreme Classic Navona
Stone	Double Rockin' Blue Savoy Re_Tour Nordik Stone
Wood	Four Seasons Nordik Wood Cozy Flaviker-Dakota Zen
Metal	Rebel
Concrete	Hyper Backstage

Decor & Wall

	Art Walls Flow Chrome
--	-----------------------------

Outdoor

X20 - 20 mm	Supreme Memories Double Rockin' Hyper Blue Savoy Still No_w Rebel Nordik Stone Re_Tour Navona Four Seasons Nordik Wood Cozy Flaviker-Dakota
X30 - 30 mm	Backstage Nordik Stone Rebel Navona Flaviker-Dakota

Technical Information

Multiple Sensations

L'Ufficio Stile Flaviker ha costruito una materioteca in grado di dare vita a molteplici combinazioni. Qui trovi gli abbinamenti più interessanti realizzabili a partire da ciascun colore della gamma Re_Tour.

The Flaviker Style Department has assembled a collection of materials that can be used in many different combinations. Here you'll find the most interesting combinations that can be created using each colour in the Re_Tour range.

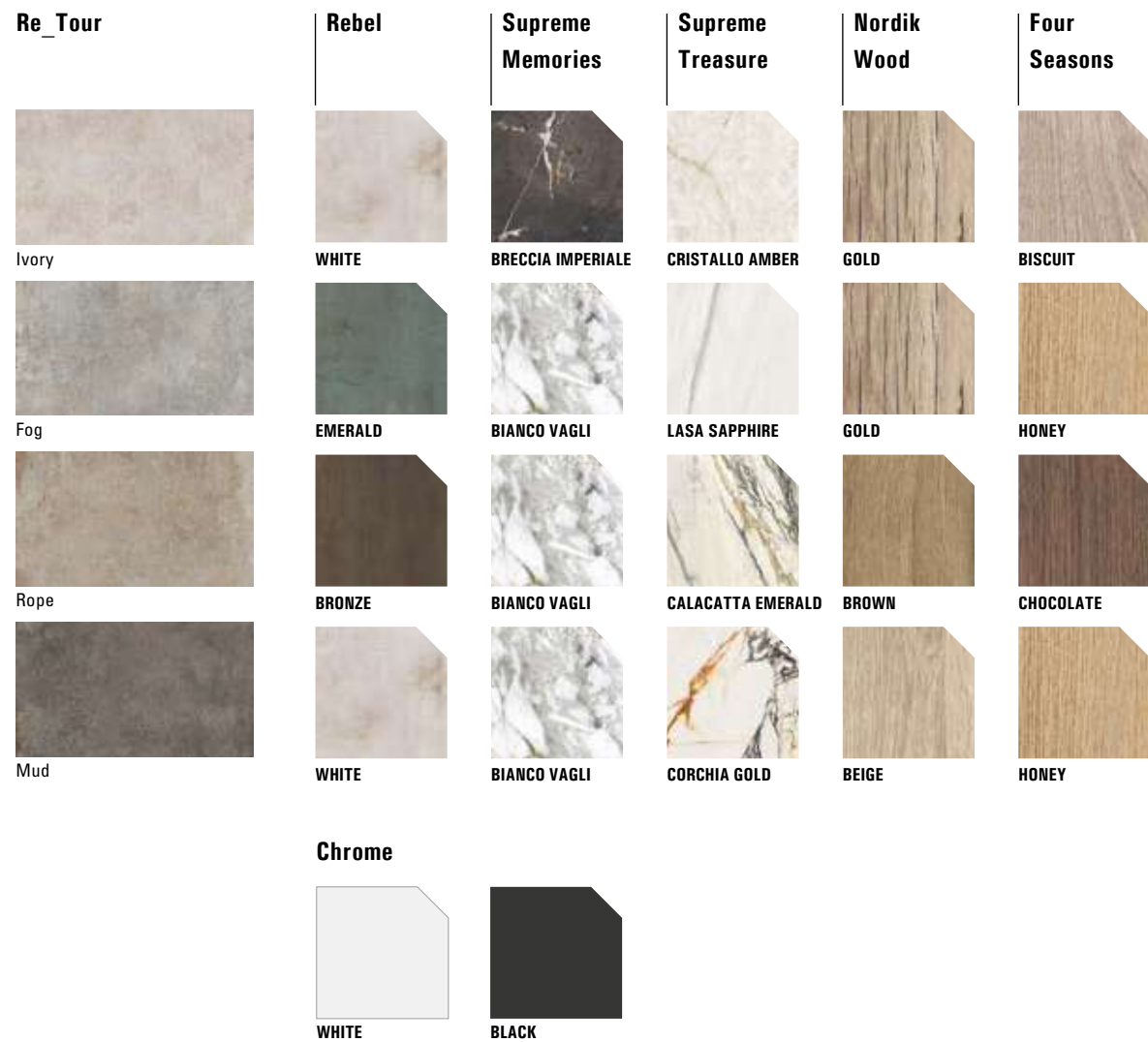

Index

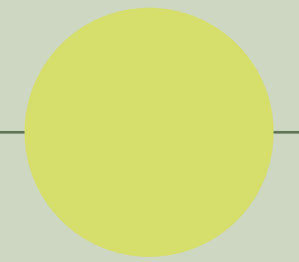

Projects

Marble	Supreme Memories Supreme Treasure Supreme Evo Supreme Classic Navona
Stone	Double Rockin' Blue Savoy Re_Tour Nordik Stone
Wood	Four Seasons Nordik Wood Cozy Flaviker-Dakota Zen
Metal	Rebel
Concrete	Hyper Backstage

Decor & Wall

	Art Walls Flow Chrome
--	-----------------------------

Outdoor

X20 - 20 mm	Supreme Memories Double Rockin' Hyper Blue Savoy Still No_w Rebel Nordik Stone Re_Tour Navona Four Seasons Nordik Wood Cozy Flaviker-Dakota
X30 - 30 mm	Backstage Nordik Stone Rebel Navona Flaviker-Dakota

Technical Information

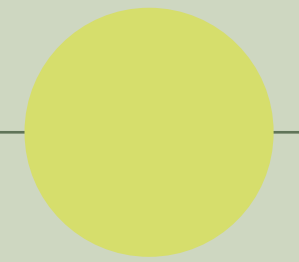

Projects

Marble	Supreme Memories Supreme Treasure Supreme Evo Supreme Classic Navona
Stone	Double Rockin' Blue Savoy Re_Tour Nordik Stone
Wood	Four Seasons Nordik Wood Cozy Flaviker-Dakota Zen
Metal	Rebel
Concrete	Hyper Backstage

Decor & Wall

	Art Walls Flow Chrome
--	-----------------------------

Outdoor

X20 - 20 mm	Supreme Memories Double Rockin' Hyper Blue Savoy Still No_w Rebel Nordik Stone Re_Tour Navona Four Seasons Nordik Wood Cozy Flaviker-Dakota
X30 - 30 mm	Backstage Nordik Stone Rebel Navona Flaviker-Dakota

Technical Information



Nordik Stone

Gres porcellanato tutta massa UGL

Full body porcelain UGL

P. tech



Complete Collection

Formati

Sizes

8,5 mm	
120x120	nat
60x120	nat
90x90	nat
60x60	nat/R11

20 mm X20	
60x120	R11
90x90	R11

30 mm X30	
90x90	R11



Ash



Grey



Black



Sand



Nordik Wood
Gold 20mm
MATERIA



Nordik Stone
Black
120x120



+
Nordik Stone
Domino Black
60x120

+
Nordik Stone
Black
60x120

+
Nordik Wood
Gold
20x120

+
Nordik Stone
Black
60x60

Stone

Nordik Stone

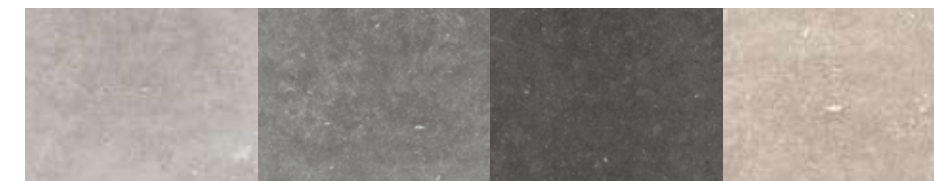

Ash Grey Black Sand

Thickness	Size	Finish	Ash	Grey	Black	Sand
8,5 mm	120x120 48"x48"	NAT RETT.	•	•	•	•
	60x120 24"x48"	NAT RETT.	•	•	•	•
	90x90 36"x36"	NAT RETT.	•	•	•	•
	60x60 24"x24"	NAT RETT.	•	•	•	•
	60x60 24"x24"	R11 RETT.	•	•		
20 mm	60x120 24"x48"	R11 RETT. P.TECH		•		•
	90x90 36"x36"	R11 RETT. P.TECH		•	•	•
30 mm	90x90 36"x36"	R11 RETT.			•	

Index

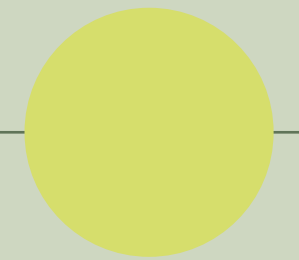

Projects

Marble	Supreme Memories Supreme Treasure Supreme Evo Supreme Classic Navona
Stone	Double Rockin' Blue Savoy Re_Tour Nordik Stone
Wood	Four Seasons Nordik Wood Cozy Flaviker-Dakota Zen
Metal	Rebel
Concrete	Hyper Backstage

Decor & Wall

	Art Walls Flow Chrome
--	-----------------------------

Outdoor

X20 - 20 mm	Supreme Memories Double Rockin' Hyper Blue Savoy Still No_w Rebel Nordik Stone Re_Tour Navona Four Seasons Nordik Wood Cozy Flaviker-Dakota
X30 - 30 mm	Backstage Nordik Stone Rebel Navona Flaviker-Dakota

Technical Information

Ash

8,5 mm			
120x120	NAT. R.	0004829	M. 80,50
60x120	NAT. R.	0004832	M. 61,90
90x90	NAT. R.	0005060	M. 61,90
60x60	NAT. R.	0004887	M. 51,50
	R11 R.	0004898	M. 51,50



Grey

8,5 mm			
120x120	NAT. R.	0003749	M. 80,50
60x120	NAT. R.	0004141	M. 61,90
90x90	NAT. R.	0005057	M. 61,90
60x60	NAT. R.	0004159	M. 51,50
	R11 R.	0004895	M. 51,50

20 mm			
	X20		
60x120	R11 R.	P.TECH	0012250 M. 87,90
90x90	R11 R.	P.TECH	0004236 M. 91,50



Black

8,5 mm			
120x120	NAT. R.	0003750	M. 80,50
60x120	NAT. R.	0004142	M. 61,90
90x90	NAT. R.	0005058	M. 61,90
60x60	NAT. R.	0004160	M. 51,50

20 mm			
	X20		
90x90	R11 R.	P.TECH	0004237 M. 91,50

30 mm			
	X30		
90x90	R11 R.		0009237 M. 142,50



Sand

8,5 mm			
120x120	NAT. R.	0003751	M. 80,50
60x120	NAT. R.	0004143	M. 61,90
90x90	NAT. R.	0005059	M. 61,90
60x60	NAT. R.	0004161	M. 51,50

20 mm			
	X20		
60x120	R11 R.	P.TECH	0012249 M. 87,90
90x90	R11 R.	P.TECH	0004238 M. 91,50



Index

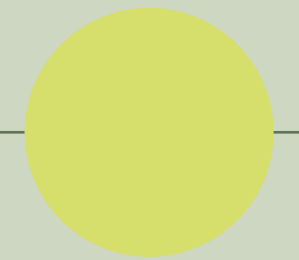

Projects

Marble	Supreme Memories Supreme Treasure Supreme Evo Supreme Classic Navona
Stone	Double Rockin' Blue Savoy Re_Tour Nordik Stone
Wood	Four Seasons Nordik Wood Cozy Flaviker-Dakota Zen
Metal	Rebel
Concrete	Hyper Backstage

Decor & Wall

Art Walls Flow Chrome

Outdoor

X20 - 20 mm	Supreme Memories Double Rockin' Hyper Blue Savoy Still No_w Rebel Nordik Stone Re_Tour Navona Four Seasons Nordik Wood Cozy Flaviker-Dakota
X30 - 30 mm	Backstage Nordik Stone Rebel Navona Flaviker-Dakota

Technical Information

MATERIA.

Disponibile anche
Available also

	Ash	Grey	Black	Sand
12 mm				
163,5x323	NAT	-	0005326	-
FULLBODY3D				
20 mm				
163,5x323	NAT	-	0007772	-
FULLBODY3D				

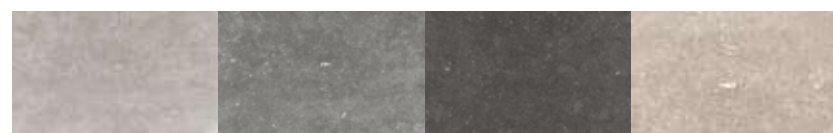

60x120
0004881
DOMINO SAND
M. 71,90
8,5 mm



60x120
0004880
DOMINO BLACK
M. 71,90
8,5 mm

Articolo composto da pattern grafici diversi che non prevedono agganci tra loro e miscelati in modo casuale in fase di inscatolamento. Non si garantisce pertanto la presenza costante di tutti i soggetti all'interno delle confezioni. / This article comes in several different versions with unconnected patterns that are mixed randomly at the time of packaging. There is therefore no guarantee that all patterns will be present in any individual box.



+ Nordik Stone Sand 60x120

+ Domino Sand 60x120

+ Nordik Wood Brown 20x120

Decor e Pezzi Speciali Decors and Special Trims		Ash	Grey	Black	Sand		
	Mix Sizes 30x60 15x60 6pz 10x60 6pz 5x60 6pz	NAT RETT.	0005192	-	0005191	M. 74,50	
	Mosaico 30x30	NAT RETT.	0004839	0004836	0004837	0004838	M. 119,50
	Battiscopa 5,5x60	NAT RETT.	0004893	0004890	0004891	0004892	P. 7,90
	Battiscopa 5,5x90	NAT RETT.	0004843	0004840	0004841	0004842	P. 9,90
	Gradone Top 32x120x4,5x2	NAT RETT.	0004847	0004844	0004845	0004846	P. 194,50
	Angolare Top SX 32x120x4,5x2	NAT RETT.	0004851	0004848	0004849	0004850	P. 225,50
	Angolare Top DX 32x120x4,5x2	NAT RETT.	0004855	0004852	0004853	0004854	P. 225,50

GRES PORCELLANATO TUTTA MASSA
FULL BODY PORCELAIN

CLASSIFICAZIONE SECONDO NORME EN 14411 (ISO 13006) ALLEGATO G GRUPPO BIa UGL
CLASSIFICATION IN ACCORDANCE WITH EN 14411 (ISO 13006) ANNEX G GROUP BIa UGL



PROPRIETÀ FISICO-CHIMICHE PHYSICAL-CHEMICAL PROPERTIES	NORMA NORM	VALORE PRESCRITTO DALLE NORME VALUE PRESCRIBED FROM THE NORMS	* VAL. / VALUE FLAVIKER NAT.	* VAL. / VALUE FLAVIKER R11
RESISTENZA ALLO SCIVOLAMENTO SLIP RESISTANCE	B.C.R.A. C.A.	μ 0,19 SCIVOLOSITÀ PERICOLOSA - DANGEROUSLY SLIPPERY 0,20 < μ < 0,39 SCIVOLOSITÀ ECCESSIVA - EXCESSIVELY SLIPPERY 0,40 < μ < 0,74 ATTRITO SODDISFACENTE - SATISFACTORY GRIP μ 0,75 ATTRITO ECCELLENTE - EXCELLENT GRIP	> 0,40	> 0,40
	B.C.R.A. G.B.		> 0,40	> 0,40
	ASTM C 1028 (S.C.O.F.)	SLIP RESISTANT (> 0,60)	> 0,60 DRY > 0,60 WET	> 0,60 DRY > 0,60 WET
	DIN 51130	IN FUNZIONE DELL'AMBIENTE O DELLA ZONA DI LAVORO BASING ON THE ENVIRONMENT OR THE WORKING AREA	R10	R11
	DIN 51097	-	A+B	A+B+C
	ANSI A 137-1:2012 (D.C.O.F.)	> 0,42	> 0,42	> 0,42

*Valori medi di produzione / Average production values

P. tech ON DEMAND

La tecnologia P.TECH migliora le performance anti-scivolo dei pavimenti, mantenendo inalterati i valori di resistenza meccanica del gres porcellanato, con una finitura estremamente piacevole al tatto e facile da pulire. **NORDIK STONE ASH, GREY e SAND in finitura P.TECH, nei formati 120x120, 60x120 e 60x60, può essere fornita su richiesta con un ordine soggetto a lotto minimo di produzione.**

The innovative P.TECH technology which improves the slip resistance of floors while delivering the renowned mechanical strength of porcelain stoneware and a finish that is both extremely pleasant to the touch and easy to clean. **NORDIK STONE ASH, GREY and SAND in P.TECH finish, in the 120x120, 60x120 and 60x60 sizes, can be supplied on request with an order subject to a minimum production batch.**

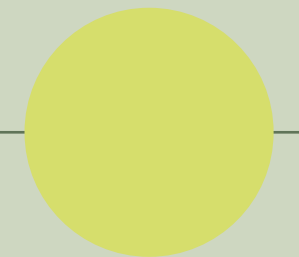

Projects

Material	Projects
Marble	Supreme Memories Supreme Treasure Supreme Evo Supreme Classic Navona
Stone	Double Rockin' Blue Savoy Re_Tour Nordik Stone
Wood	Four Seasons Nordik Wood Cozy Flaviker-Dakota Zen
Metal	Rebel
Concrete	Hyper Backstage

Decor & Wall

Art Walls Flow Chrome

Outdoor

X20 - 20 mm	Projects
	Supreme Memories Double Rockin' Hyper Blue Savoy Still No_w Rebel Nordik Stone Re_Tour Navona Four Seasons Nordik Wood Cozy Flaviker-Dakota
X30 - 30 mm	Projects
	Backstage Nordik Stone Rebel Navona Flaviker-Dakota

Technical Information

Multiple Sensations

L'Ufficio Stile Flaviker ha costruito una materioteca in grado di dare vita a molteplici combinazioni. Qui trovi gli abbinamenti più interessanti realizzabili a partire da ciascun colore della gamma Nordik Stone.

The Flaviker Style Department has assembled a collection of materials that can be used in many different combinations. Here you'll find the most interesting combinations that can be created using each colour in the Nordik Stone range.

Nordik Stone

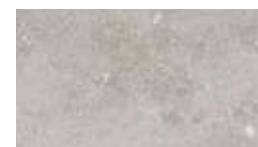

Ash

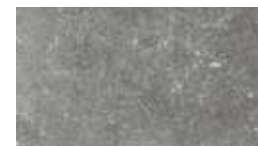

Grey

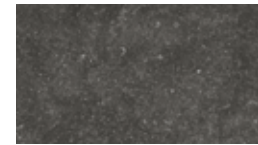

Black



Sand

Rebel



LEAD



WHITE



SILVER



LEAD

Chrome



WHITE



BLACK

Supreme Memories



BIANCO VAGLI



BIANCO VAGLI

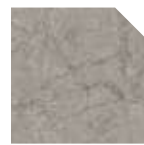

GREY SOAPSTONE



BRECCIA IMPERIALE

Supreme Treasure/Evo



CALACATTA EMERALD



INVISIBLE SELECT



CORCHIA GOLD



CALACATTA EXTRA

Four Seasons



HONEY



BISCUIT



HONEY



CHOCOLATE

Nordik Wood



SMOKED



GOLD



BEIGE



BROWN



Nordik Wood Gold

Nordik Stone Black

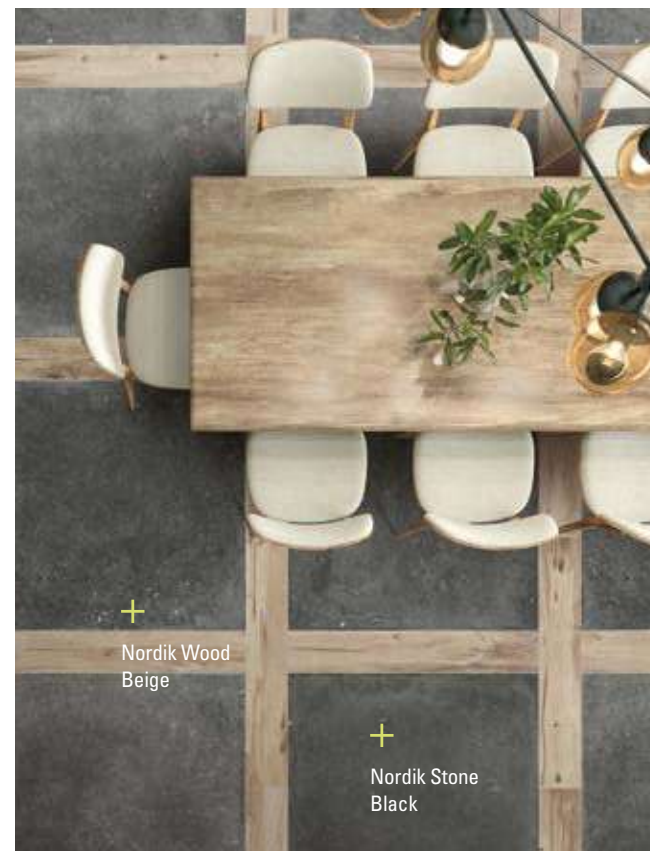

Nordik Wood Beige

Nordik Stone Black



Supreme Memories Breccia Imperiale

Nordik Stone Sand



Nordik Stone Sand

Rebel Lead

Index

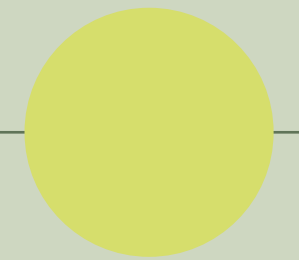

Projects

Marble	Supreme Memories Supreme Treasure Supreme Evo Supreme Classic Navona
Stone	Double Rockin' Blue Savoy Re_Tour Nordik Stone
Wood	Four Seasons Nordik Wood Cozy Flaviker-Dakota Zen
Metal	Rebel
Concrete	Hyper Backstage

Decor & Wall

Art Walls Flow Chrome

Outdoor

X20 - 20 mm	Supreme Memories Double Rockin' Hyper Blue Savoy Still No_w Rebel Nordik Stone Re_Tour Navona Four Seasons Nordik Wood Cozy Flaviker-Dakota
X30 - 30 mm	Backstage Nordik Stone Rebel Navona Flaviker-Dakota

Technical Information



+
Four Seasons
Industrial Honey
20x120

Wood

+ Four Seasons

Gres porcellanato a massa colorata UGL
Full body colored porcelain UGL

P. tech

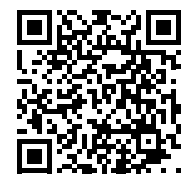

Complete Collection

Formati

Sizes

6 mm
120x280 nat
26x200 nat

8,5 mm
30x120 nat
20x120 nat
5x120 nat
10x60 nat
7,5x40,7 chevron nat

20 mm X20
30x120 R11
30x180 R11



Chocolate



Biscuit



Honey

Index

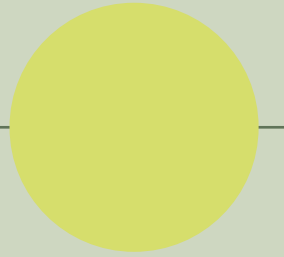

Projects

Marble	Supreme Memories Supreme Treasure Supreme Evo Supreme Classic Navona
Stone	Double Rockin' Blue Savoy Re_Tour Nordik Stone
Wood	Four Seasons Nordik Wood Cozy Flaviker-Dakota Zen
Metal	Rebel
Concrete	Hyper Backstage

Decor & Wall

	Art Walls Flow Chrome
--	-----------------------------

Outdoor

X20 - 20 mm	Supreme Memories Double Rockin' Hyper Blue Savoy Still No_w Rebel Nordik Stone Re_Tour Navona Four Seasons Nordik Wood Cozy Flaviker-Dakota
X30 - 30 mm	Backstage Nordik Stone Rebel Navona Flaviker-Dakota

Technical Information



Wood

Four Seasons



Chocolate Biscuit Honey

6 mm	120x280 48"x112"	NAT RETT.			•
	26x200 10"x78"	NAT RETT. P. TECH R10 C	•	•	•
8,5 mm	30x120 12"x48"	NAT RETT. P. TECH R10 C	•	•	•
	20x120 8"x48"	NAT RETT. P. TECH R10 C	•	•	•
	5x120 2"x48"	NAT RETT. P. TECH R10 C	•	•	•
	10x60 4"x24"	NAT RETT. P. TECH R10 C	•	•	•
	7,5x40,7 3"x16" CHEVRON	NAT	•	•	•
20 mm X20	30x180 12"x71"	R11 RETT. P. TECH	•	•	•
	30x120 12"x48"	R11 RETT. P. TECH	•	•	•

Index

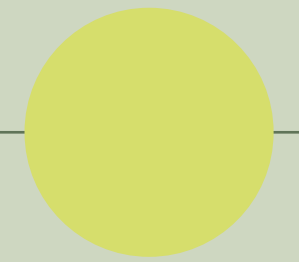

Projects

Marble	Supreme Memories Supreme Treasure Supreme Evo Supreme Classic Navona
Stone	Double Rockin' Blue Savoy Re_Tour Nordik Stone
Wood	Four Seasons Nordik Wood Cozy Flaviker-Dakota Zen
Metal	Rebel
Concrete	Hyper Backstage

Decor & Wall

	Art Walls Flow Chrome
--	-----------------------------

Outdoor

X20 - 20 mm	Supreme Memories Double Rockin' Hyper Blue Savoy Still No_w Rebel Nordik Stone Re_Tour Navona Four Seasons Nordik Wood Cozy Flaviker-Dakota
X30 - 30 mm	Backstage Nordik Stone Rebel Navona Flaviker-Dakota

Technical Information

Chocolate

6 mm					
26x200	NAT. R.	P.TECH R10 C	0011803	M.	78,90
8,5 mm					
30x120	NAT. R.	P.TECH R10 C	0011806	M.	61,90
20x120	NAT. R.	P.TECH R10 C	0011809	M.	60,50
5x120	NAT. R.	P.TECH R10 C	0012950	M.	166,50
10x60	NAT. R.	P.TECH R10 C	0011812	M.	74,50
20 mm X20					
30x180	R11 R.	P.TECH	0012201	M.	100,50
30x120	R11 R.	P.TECH	0011818	M.	87,90



Biscuit

6 mm					
26x200	NAT. R.	P.TECH R10 C	0011805	M.	78,90
8,5 mm					
30x120	NAT. R.	P.TECH R10 C	0011808	M.	61,90
20x120	NAT. R.	P.TECH R10 C	0011811	M.	60,50
5x120	NAT. R.	P.TECH R10 C	0012952	M.	166,50
10x60	NAT. R.	P.TECH R10 C	0011814	M.	74,50
20 mm X20					
30x180	R11 R.	P.TECH	0012203	M.	100,50
30x120	R11 R.	P.TECH	0011820	M.	87,90



Honey

6 mm					
120x280	NAT. R.		0012916	M.	101,90
26x200	NAT. R.	P.TECH R10 C	0011804	M.	78,90
8,5 mm					
30x120	NAT. R.	P.TECH R10 C	0011807	M.	61,90
20x120	NAT. R.	P.TECH R10 C	0011810	M.	60,50
5x120	NAT. R.	P.TECH R10 C	0012951	M.	166,50
10x60	NAT. R.	P.TECH R10 C	0011813	M.	74,50
20 mm X20					
30x180	R11 R.	P.TECH	0012202	M.	100,50
30x120	R11 R.	P.TECH	0011819	M.	87,90



Chevron

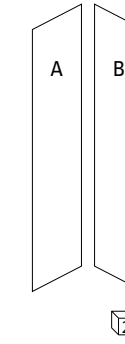

Chocolate

8,5 mm	7,5x40,7	CHEVRON NAT	0012463	M	66,90
--------	----------	-------------	---------	---	-------

Biscuit

8,5 mm	7,5x40,7	CHEVRON NAT	0012465	M	66,90
--------	----------	-------------	---------	---	-------

Honey

8,5 mm	7,5x40,7	CHEVRON NAT	0012464	M	66,90
--------	----------	-------------	---------	---	-------

Index



Projects

Marble	Supreme Memories Supreme Treasure Supreme Evo Supreme Classic Navona
Stone	Double Rockin' Blue Savoy Re_Tour Nordik Stone
Wood	Four Seasons Nordik Wood Cozy Flaviker-Dakota Zen
Metal	Rebel
Concrete	Hyper Backstage

Decor & Wall

Art Walls Flow Chrome

Outdoor

X20 - 20 mm	Supreme Memories Double Rockin' Hyper Blue Savoy Still No_w Rebel Nordik Stone Re_Tour Navona Four Seasons Nordik Wood Cozy Flaviker-Dakota
X30 - 30 mm	Backstage Nordik Stone Rebel Navona Flaviker-Dakota

Technical Information



120x280
0012917
STRIP NAT. RETT.
M. 122,50

6 mm

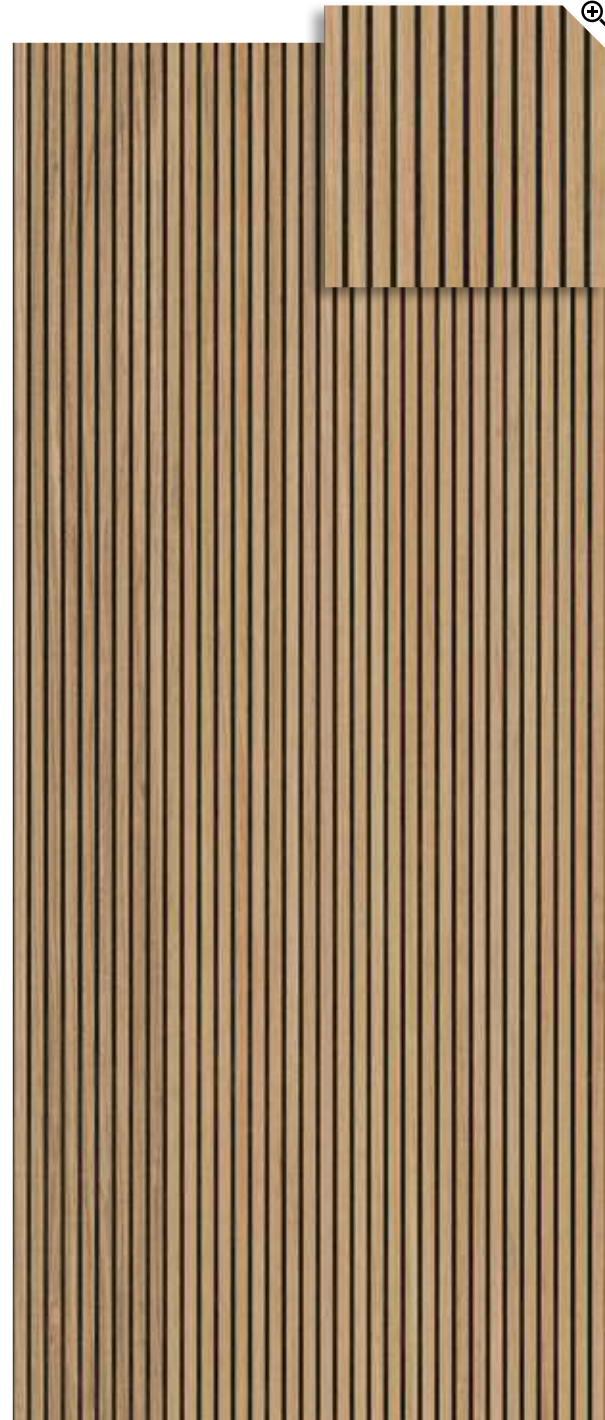

120x280
0012918
MIX NAT. RETT.
M. 122,50

6 mm

Articolo composto da pattern grafici diversi che non prevedono agganci tra loro e miscelati in modo casuale in fase di inscatolamento. Non si garantisce pertanto la presenza costante di tutti i soggetti all'interno delle confezioni. / This article comes in several different versions with unconnected patterns that are mixed randomly at the time of packaging. There is therefore no guarantee that all patterns will be present in any individual box.

Ripresa grafica tra le diverse lastre contenuta entro una tolleranza di 3mm. / Graphic clearance among the different slabs ranging within 3mm.



+
Four Seasons
Strip
120x280

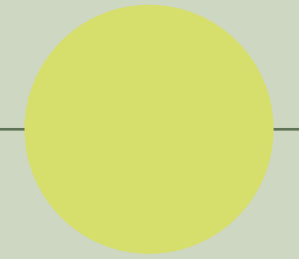

Projects

Marble	Supreme Memories Supreme Treasure Supreme Evo Supreme Classic Navona
Stone	Double Rockin' Blue Savoy Re_Tour Nordik Stone
Wood	Four Seasons Nordik Wood Cozy Flaviker-Dakota Zen
Metal	Rebel
Concrete	Hyper Backstage

Decor & Wall

	Art Walls Flow Chrome
--	-----------------------------

Outdoor

X20 - 20 mm	Supreme Memories Double Rockin' Hyper Blue Savoy Still No_w Rebel Nordik Stone Re_Tour Navona Four Seasons Nordik Wood Cozy Flaviker-Dakota
X30 - 30 mm	Backstage Nordik Stone Rebel Navona Flaviker-Dakota

Technical Information



20x120
0011815
INDUSTRIAL CHOCOLATE NAT RETT. P.TECH R10 C
M. 66,90



20x120
0011817
INDUSTRIAL BISCUIT NAT RETT. P.TECH R10 C
M. 66,90



20x120
0011816
INDUSTRIAL HONEY NAT RETT. P.TECH R10 C
M. 66,90

Articolo composto da pattern grafici diversi che non prevedono agganci tra loro e miscelati in modo casuale in fase di inscatolamento. Non si garantisce pertanto la presenza costante di tutti i soggetti all'interno delle confezioni. / This article comes in several different versions with unconnected patterns that are mixed randomly at the time of packaging. There is therefore no guarantee that all patterns will be present in any individual box.

MATERIA.

Disponibile anche
Available also



Chocolate Biscuit Honey

12 mm	NAT	-	-	0013074
163,5x323				
20 mm	NAT	-	-	0013075
163,5x323				

Decor
e Pezzi Speciali
Decors
and Special Trims



Chocolate Biscuit Honey

	Battiscopa 6,5x120 8,5 mm	NAT RETT. P. TECH R10 C	0012358	0012361	0012360	P. 11,50
	Gradone Top 32x120x4,5x2 8,5 mm	NAT RETT. P. TECH R10 C	0012362	0012364	0012363	P. 194,50
	Angolare Top SX 32x120x4,5x2 8,5 mm	NAT RETT. P. TECH R10 C	0012365	0012367	0012366	P. 225,50
	Angolare Top DX 32x120x4,5x2 8,5 mm	NAT RETT. P. TECH R10 C	0012368	0012370	0012369	P. 225,50

GRES PORCELLANATO A MASSA COLORATA
FULL BODY COLORED PORCELAIN
CLASSIFICAZIONE SECONDO NORME EN 14411 (ISO 13006) ALLEGATO G GRUPPO B1a UGL
CLASSIFICATION IN ACCORDANCE WITH EN 14411 (ISO 13006) ANNEX G GROUP B1a UGL



PROPRIETÀ FISICO-CHIMICHE PHYSICAL-CHEMICAL PROPERTIES	NORMA NORM	VALORE PRESCRITTO DALLE NORME VALUE PRESCRIBED FROM THE NORMS	* VAL. / VALUE FLAVIKER NAT. P.TECH	* VAL. / VALUE FLAVIKER R11 P. TECH
RESISTENZA ALLO SCIVOLAMENTO SLIP RESISTANCE	B.C.R.A. C.A.	a PERICOLOSA - DANGEROUSLY SLIPPERY 0,20 < μ < 0,39 SCIVOLosità ECCESSIVA - EXCESSIVELY SLIPPERY 0,40 < μ < 0,74 ATTRITO SODDISFACENTE - SATISFACTORY GRIP μ 0,75 ATTRITO ECCELLENTE - EXCELLENT GRIP	> 0,40	> 0,40
	B.C.R.A. G.B.		> 0,40	> 0,40
	ASTM C 1028 (S.C.O.F.)	SLIP RESISTANT (> 0,60)	> 0,60 DRY > 0,60 WET	> 0,60 DRY > 0,60 WET
	DIN 51130	IN FUNZIONE DELL'AMBIENTE O DELLA ZONA DI LAVORO BASING ON THE ENVIRONMENT OR THE WORKING AREA	R10	R11
	DIN 51097	-	A+B+C	A+B+C
	ANSI A 137-1:2012 (D.C.O.F.)	> 0,42	> 0,42	> 0,42
	AS/NZS 4586:2013	SRV : 35 - 44	P3 WET	P4 WET
	BS 7976 - 2:2002	> 36	+36 WET	+36 WET

*Valori medi di produzione / Average production values

Index

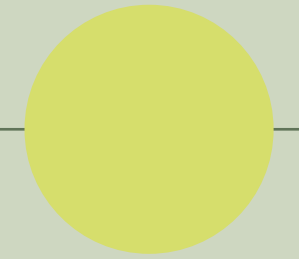

Projects

Marble	Supreme Memories Supreme Treasure Supreme Evo Supreme Classic Navona
Stone	Double Rockin' Blue Savoy Re_Tour Nordik Stone
Wood	Four Seasons Nordik Wood Cozy Flaviker-Dakota Zen
Metal	Rebel
Concrete	Hyper Backstage

Decor & Wall

Art Walls Flow Chrome

Outdoor

X20 - 20 mm	Supreme Memories Double Rockin' Hyper Blue Savoy Still No_w Rebel Nordik Stone Re_Tour Navona Four Seasons Nordik Wood Cozy Flaviker-Dakota
X30 - 30 mm	Backstage Nordik Stone Rebel Navona Flaviker-Dakota

Technical Information



+
 Nordik Wood
 Beige
 26x200

+
**Nordik
 Wood**

Gres porcellanato a massa colorata
 Full body colored porcelain



Complete Collection

Formati

Sizes

6 mm
 26x200 nat

8,5 mm
 20x120 nat/ R11
 10x60 nat

20 mm X20
 30x180 R11
 30x120 R11



Gold



Beige



Brown



Smoked

Index

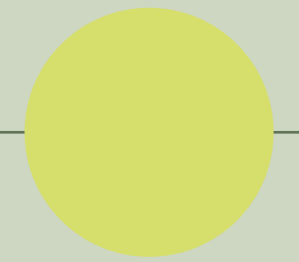

Projects

Marble	Supreme Memories Supreme Treasure Supreme Evo Supreme Classic Navona
Stone	Double Rockin' Blue Savoy Re_Tour Nordik Stone
Wood	Four Seasons Nordik Wood Cozy Flaviker-Dakota Zen
Metal	Rebel
Concrete	Hyper Backstage

Decor & Wall

	Art Walls Flow Chrome
--	-----------------------------

Outdoor

X20 - 20 mm	Supreme Memories Double Rockin' Hyper Blue Savoy Still No_w Rebel Nordik Stone Re_Tour Navona Four Seasons Nordik Wood Cozy Flaviker-Dakota
X30 - 30 mm	Backstage Nordik Stone Rebel Navona Flaviker-Dakota

Technical Information



+
X20 Nordik Wood Gold
30x120 20 mm

Wood

Nordik Wood



Gold Beige Brown Smoked

Thickness	Dimensions	Finish	Gold	Beige	Brown	Smoked
6 mm	26x200 10"x78"	NAT RETT.	•	•		
8,5 mm	20x120 8"x48"	NAT RETT.	•	•	•	•
	20x120 8"x48"	R11 RETT.	•	•	•	•
	10x60 4"x24"	NAT RETT.	•	•		
20 mm X20	30x180 12"x71"	R11 RETT. P.TECH	•	•	•	
	30x120 12"x48"	R11 RETT. P.TECH	•	•		

Index

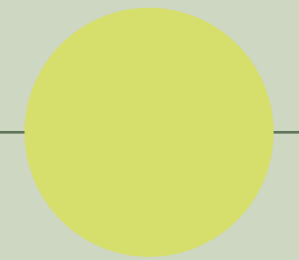

Projects

Material	Projects
Marble	Supreme Memories Supreme Treasure Supreme Evo Supreme Classic Navona
Stone	Double Rockin' Blue Savoy Re_Tour Nordik Stone
Wood	Four Seasons Nordik Wood Cozy Flaviker-Dakota Zen
Metal	Rebel
Concrete	Hyper Backstage

Decor & Wall

Art Walls Flow Chrome

Outdoor

Thickness	Projects
X20 - 20 mm	Supreme Memories Double Rockin' Hyper Blue Savoy Still No_w Rebel Nordik Stone Re_Tour Navona Four Seasons Nordik Wood Cozy Flaviker-Dakota
X30 - 30 mm	Backstage Nordik Stone Rebel Navona Flaviker-Dakota

Technical Information

Gold

6 mm				
26x200	NAT. R.		0003673	M. 78,90
8,5 mm				
20x120	NAT. R.		0003687	M. 55,90
	R11 R.		0004609	M. 55,90
10x60	NAT. R.		0007818	M. 72,90
20 mm X20				
30x180	R11 R.	P.TECH	0006454	M. 100,50
30x120	R11 R.	P.TECH	0004816	M. 87,90



152 X20 Per la serie completa vedi pag.: 243 / For the complete collection see at page: 243

Beige

6 mm				
26x200	NAT. R.		0003672	M. 78,90
8,5 mm				
20x120	NAT. R.		0003686	M. 55,90
	R11 R.		0004608	M. 55,90
10x60	NAT. R.		0007817	M. 72,90
20 mm X20				
30x180	R11 R.	P.TECH	0008906	M. 100,50
30x120	R11 R.	P.TECH	0004815	M. 87,90



Brown

8,5 mm				
20x120	NAT. R.		0003688	M. 55,90
	R11 R.		0004610	M. 55,90
20 mm X20				
30x180	R11 R.	P.TECH	0006455	M. 100,50



X20 Per la serie completa vedi pag.: 243 / For the complete collection see at page: 243

Smoked

8,5 mm				
20x120	NAT. R.		0003689	M. 55,90
	R11 R.		0004611	M. 55,90



153

Index

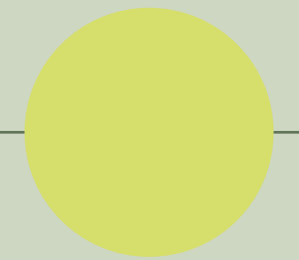

Projects

Marble	Supreme Memories Supreme Treasure Supreme Evo Supreme Classic Navona
Stone	Double Rockin' Blue Savoy Re_Tour Nordik Stone
Wood	Four Seasons Nordik Wood Cozy Flaviker-Dakota Zen
Metal	Rebel
Concrete	Hyper Backstage

Decor & Wall

	Art Walls Flow Chrome
--	-----------------------------

Outdoor

X20 - 20 mm	Supreme Memories Double Rockin' Hyper Blue Savoy Still No_w Rebel Nordik Stone Re_Tour Navona Four Seasons Nordik Wood Cozy Flaviker-Dakota
X30 - 30 mm	Backstage Nordik Stone Rebel Navona Flaviker-Dakota

Technical Information



60x60
0005045
PALACE BEIGE / GOLD
M.59,50

8,5 mm



60x60
0005047
MANSION GOLD / BROWN
M.59,50

8,5 mm

La non perfetta continuità di linee, rilievi o motivi grafici tra piastrelle adiacenti è naturale conseguenza del processo produttivo, pertanto non costituisce un vizio del prodotto.
Any variations in graphic designs or textures between adjacent tiles are a natural consequence of the manufacturing process and do not constitute a product defect.



60x120
0004881
DOMINO SAND
M. 71,90

8,5 mm



60x120
0004880
DOMINO BLACK
M. 71,90

8,5 mm

Articolo composto da pattern grafici diversi che non prevedono agganci tra loro e miscelati in modo casuale in fase di inscatolamento. Non si garantisce pertanto la presenza costante di tutti i soggetti all'interno delle confezioni. / This article comes in several different versions with unconnected patterns that are mixed randomly at the time of packaging. There is therefore no guarantee that all patterns will be present in any individual box.

**Decor
e Pezzi Speciali**
Decors
and Special Trims



			Gold	Beige	Brown	Smoked	
	Mosaico 30x30	NAT RETT.	0004613	0004612	0004614	0004615	M. 119,50
	Battiscopa 6,5x120	NAT RETT.	0004617	0004616	0004618	0004619	P. 11,50
	Gradone Top 32x120x4,5x2	NAT RETT.	0004621	0004620	0004622	0004623	P. 194,50
	Angolare Top SX 32x120x4,5x2	NAT RETT.	0004625	0004624	0004626	0004627	P. 225,50
	Angolare Top DX 32x120x4,5x2	NAT RETT.	0004629	0004628	0004630	0004631	P. 225,50

GRES PORCELLANATO A MASSA COLORATA
FULL BODY COLORED PORCELAIN

CLASSIFICAZIONE SECONDO NORME EN 14411 (ISO 13006) ALLEGATO G GRUPPO B1a GL
CLASSIFICATION IN ACCORDANCE WITH EN 14411 (ISO 13006) ANNEX G GROUP B1a GL



PROPRIETÀ FISICO-CHIMICHE PHYSICAL-CHEMICAL PROPERTIES	NORMA NORM	VALORE PRESCRITTO DALLE NORME VALUE PRESCRIBED FROM THE NORMS	* VAL. / VALUE FLAVIKER NAT.	* VAL. / VALUE FLAVIKER R11
RESISTENZA ALLO SCIVOLAMENTO SLIP RESISTANCE	B.C.R.A. C.A.	<small>μ</small> PERICOLOSA - DANGEROUSLY SLIPPERY 0,20 < <small>μ</small> < 0,39 SCIVOLosità ECCESSIVA - EXCESSIVELY SLIPPERY 0,40 < <small>μ</small> < 0,74 ATTRITO SODDISFACENTE - SATISFACTORY GRIP <small>μ</small> 0,75 ATTRITO ECCELLENTE - EXCELLENT GRIP	> 0,40	> 0,40
	B.C.R.A. G.B.		> 0,40	> 0,40
	ASTM C 1028 (S.C.O.F.)	SLIP RESISTANT (> 0,60)	> 0,60 DRY > 0,60 WET	> 0,60 DRY > 0,60 WET
	DIN 51130	IN FUNZIONE DELL'AMBIENTE O DELLA ZONA DI LAVORO BASING ON THE ENVIRONMENT OR THE WORKING AREA	R10	R11
	DIN 51097	-	A+B	A+B+C
	ANSI A 137-1:2012 (D.C.O.F.)	> 0,42	> 0,42	> 0,42

*Valori medi di produzione / Average production values

Index

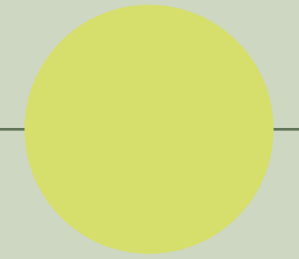

Projects

Material	Projects
Marble	Supreme Memories Supreme Treasure Supreme Evo Supreme Classic Navona
Stone	Double Rockin' Blue Savoy Re_Tour Nordik Stone
Wood	Four Seasons Nordik Wood Cozy Flaviker-Dakota Zen
Metal	Rebel
Concrete	Hyper Backstage

Decor & Wall

Art Walls Flow Chrome

Outdoor

X20 - 20 mm	Projects
	Supreme Memories Double Rockin' Hyper Blue Savoy Still No_w Rebel Nordik Stone Re_Tour Navona Four Seasons Nordik Wood Cozy Flaviker-Dakota
X30 - 30 mm	Projects
	Backstage Nordik Stone Rebel Navona Flaviker-Dakota

Technical Information



Wood

+
Cozy

Gres porcellanato a massa colorata
Full body colored porcelain



Complete Collection

Formati

Sizes

6 mm
26x200 nat

8,5 mm
20x120 nat

20 mm X20
30x180 R11
30x120 R11



Havana



Honey



Desert



Brown



Bark

+
Cozy
Havana
20x120

Index

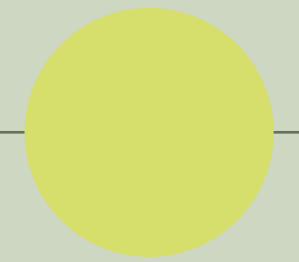

Projects

Marble	Supreme Memories Supreme Treasure Supreme Evo Supreme Classic Navona
Stone	Double Rockin' Blue Savoy Re_Tour Nordik Stone
Wood	Four Seasons Nordik Wood Cozy Flaviker-Dakota Zen
Metal	Rebel
Concrete	Hyper Backstage

Decor & Wall

Art Walls Flow Chrome

Outdoor

X20 - 20 mm	Supreme Memories Double Rockin' Hyper Blue Savoy Still No_w Rebel Nordik Stone Re_Tour Navona Four Seasons Nordik Wood Cozy Flaviker-Dakota
X30 - 30 mm	Backstage Nordik Stone Rebel Navona Flaviker-Dakota

Technical Information



Wood

Cozy



Havana Honey Desert Brown Bark

Thickness	Dimensions	Finish	Havana	Honey	Desert	Brown	Bark
6 mm	26x200 10"x78"	NAT RETT.	•	•	•	•	•
8,5 mm	20x120 8"x48"	NAT RETT.	•	•	•	•	•
20 mm	30x180 12"x71"	R11 RETT. P.TECH	•			•	
	30x120 12"x48"	R11 RETT. P.TECH	•				•

+
Cozy
Brown
26x200

Index

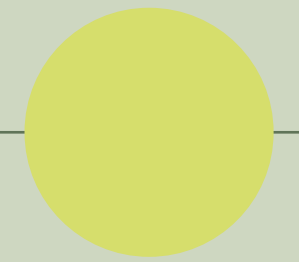

Projects

Marble	Supreme Memories Supreme Treasure Supreme Evo Supreme Classic Navona
Stone	Double Rockin' Blue Savoy Re_Tour Nordik Stone
Wood	Four Seasons Nordik Wood Cozy Flaviker-Dakota Zen
Metal	Rebel
Concrete	Hyper Backstage

Decor & Wall

	Art Walls Flow Chrome
--	-----------------------------

Outdoor

X20 - 20 mm	Supreme Memories Double Rockin' Hyper Blue Savoy Still No_w Rebel Nordik Stone Re_Tour Navona Four Seasons Nordik Wood Cozy Flaviker-Dakota
X30 - 30 mm	Backstage Nordik Stone Rebel Navona Flaviker-Dakota

Technical Information

Havana

6 mm				
26x200	NAT. R.		0002342	M. 78,90
8,5 mm				
20x120	NAT. R.		0002344	M. 55,90
20 mm X20				
30x180	R11 R.	P.TECH	0006566	M. 100,50
30x120	R11 R.	P.TECH	0003084	M. 87,90



20x120

Honey

6 mm				
26x200	NAT. R.		0000472	M. 78,90
8,5 mm				
20x120	NAT. R.		0000475	M. 55,90



20x120

Desert

6 mm				
26x200	NAT. R.		0000471	M. 78,90
8,5 mm				
20x120	NAT. R.		0000474	M. 55,90



20x120

Brown

6 mm				
26x200	NAT. R.		0001079	M. 78,90
8,5 mm				
20x120	NAT. R.		0001078	M. 55,90
20 mm X20				
30x180	R11 R.	P.TECH	0006567	M. 100,50



20x120

Index

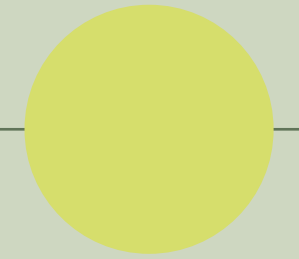

Projects

Marble	Supreme Memories Supreme Treasure Supreme Evo Supreme Classic Navona
Stone	Double Rockin' Blue Savoy Re_Tour Nordik Stone
Wood	Four Seasons Nordik Wood Cozy Flaviker-Dakota Zen
Metal	Rebel
Concrete	Hyper Backstage

Decor & Wall

	Art Walls Flow Chrome
--	-----------------------------

Outdoor

X20 - 20 mm	Supreme Memories Double Rockin' Hyper Blue Savoy Still No_w Rebel Nordik Stone Re_Tour Navona Four Seasons Nordik Wood Cozy Flaviker-Dakota
X30 - 30 mm	Backstage Nordik Stone Rebel Navona Flaviker-Dakota

Technical Information

Bark

6 mm				
26x200	NAT. R.		0000473	M. 78,90
8,5 mm				
20x120	NAT. R.		0000476	M. 55,90
20 mm	X20			
30x120	R11 R.	P.TECH	0003085	M. 87,90



		Havana	Honey	Desert	Brown	Bark		
Decor e Pezzi Speciali Decors and Special Trims								
 8,5 mm	Mosaico Triangoli * 34x26	NAT. RETT.	0002350	0001281	0001280	0001283	0001282	M. 400,90
 7 mm	Triangolo 30	NAT. RETT.	0002345	0001112	0001111	0001114	0001113	M. 214,50
 8,5 mm	Battiscopa 6,5x120	NAT. RETT.	0002346	0001264	0001263	0001266	0001265	P. 11,50
 8,5 mm	Gradone Top 32x120x4,5x2	NAT. RETT.	0002347	0001268	0001267	0001270	0001269	P. 194,50
 8,5 mm	Angolare Top SX 32x120x4,5x2	NAT. RETT.	0002348	0001272	0001271	0001274	0001273	P. 225,50
 8,5 mm	Angolare Top DX 32x120x4,5x2	NAT. RETT.	0002349	0001276	0001275	0001278	0001277	P. 225,50

* Fino ad esaurimento scorte l'art. verrà consegnato con spessore 7 mm. / The item will be delivered 7 mm thickness while stocks last.

GRES PORCELLANATO A MASSA COLORATA
FULL BODY COLORED PORCELAIN

CLASSIFICAZIONE SECONDO NORME EN 14411 (ISO 13006) ALLEGATO G GRUPPO BIa GL
CLASSIFICATION IN ACCORDANCE WITH EN 14411 (ISO 13006) ANNEX G GROUP BIa GL



PROPRIETÀ FISICO-CHIMICHE PHYSICAL-CHEMICAL PROPERTIES	NORMA NORM	VALORE PRESCRITTO DALLE NORME VALUE PRESCRIBED FROM THE NORMS	* VAL. / VALUE FLAVIKER NAT.	* VAL. / VALUE FLAVIKER R11 P. TECH
RESISTENZA ALLO SCIVOLAMENTO SLIP RESISTANCE	B.C.R.A. C.A.	a PERICOLOSA - DANGEROUSLY SLIPPERY 0,20 < μ < 0,39 SCIVOLosità ECCESSIVA - EXCESSIVELY SLIPPERY 0,40 < μ < 0,74 ATTRITO SODDISFACENTE - SATISFACTORY GRIP μ 0,75 ATTRITO ECCELLENTE - EXCELLENT GRIP	> 0,40	> 0,40
	B.C.R.A. G.B.		> 0,40	> 0,40
	ASTM C 1028 (S.C.O.F.)	SLIP RESISTANT (> 0,60)	> 0,60 DRY > 0,60 WET	> 0,60 DRY > 0,60 WET
	DIN 51130	IN FUNZIONE DELL'AMBIENTE O DELLA ZONA DI LAVORO BASING ON THE ENVIRONMENT OR THE WORKING AREA	R10	R11
	DIN 51097	-	A+B	A+B+C
	ANSI A 137-1:2012 (D.C.O.F.)	> 0,42	> 0,42	> 0,42

*Valori medi di produzione / Average production values

Index

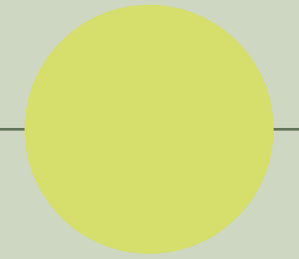

Projects

Marble	Supreme Memories Supreme Treasure Supreme Evo Supreme Classic Navona
Stone	Double Rockin' Blue Savoy Re_Tour Nordik Stone
Wood	Four Seasons Nordik Wood Cozy Flaviker-Dakota Zen
Metal	Rebel
Concrete	Hyper Backstage

Decor & Wall

	Art Walls Flow Chrome
--	-----------------------------

Outdoor

X20 - 20 mm	Supreme Memories Double Rockin' Hyper Blue Savoy Still No_w Rebel Nordik Stone Re_Tour Navona Four Seasons Nordik Wood Cozy Flaviker-Dakota
X30 - 30 mm	Backstage Nordik Stone Rebel Navona Flaviker-Dakota

Technical Information



+
Flaviker Dakota
Reserve Grigio
20x120

Wood

+ Flaviker-Dakota

Gres porcellanato a massa colorata
Full body colored porcelain



Complete Collection

Formati

Sizes

8,5 mm	
40x170	nat
20x170	nat
20x120	nat/ R11
30x120	nat
20x80	nat
20 mm X20	
30x180	R11
30x120	R11
30 mm X30	
30x120	R11



Naturale



Avana



Grigio



Tortora

Index

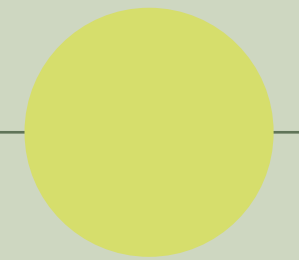

Projects

Marble	Supreme Memories Supreme Treasure Supreme Evo Supreme Classic Navona
Stone	Double Rockin' Blue Savoy Re_Tour Nordik Stone
Wood	Four Seasons Nordik Wood Cozy Flaviker-Dakota Zen
Metal	Rebel
Concrete	Hyper Backstage

Decor & Wall

	Art Walls Flow Chrome
--	-----------------------------

Outdoor

X20 - 20 mm	Supreme Memories Double Rockin' Hyper Blue Savoy Still No_w Rebel Nordik Stone Re_Tour Navona Four Seasons Nordik Wood Cozy Flaviker-Dakota
X30 - 30 mm	Backstage Nordik Stone Rebel Navona Flaviker-Dakota

Technical Information



+
 Flaviker Dakota
 Naturale
 20x170 - 20x120

Wood

Flaviker-Dakota



Naturale Avana Grigio Tortora

Thickness	Size	Finish	Naturale	Avana	Grigio	Tortora
8,5 mm	40x170 8"x68"	NAT RETT.	•	•	•	•
	20x170 8"x68"	NAT RETT.	•	•	•	•
	20x120 8"x48"	NAT RETT.	•	•	•	•
	20x120 8"x48"	R11 RETT. RESERVE	•	•	•	•
	30x120 12"x48"	NAT RETT.	•	•	•	•
	20x80 8"x24"	NAT RETT.	•	•	•	•
20 mm	30x180 12"x71"	R11 RETT.	•			
	30x120 12"x48"	R11 RETT. P. TECH	•	•		
30 mm	30x180 12"x71"	R11 RETT. P. TECH	•			

Index

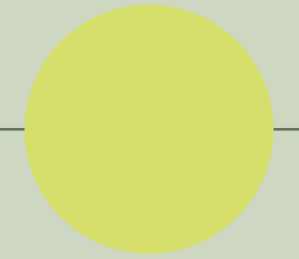

Projects

Marble	Supreme Memories Supreme Treasure Supreme Evo Supreme Classic Navona
Stone	Double Rockin' Blue Savoy Re_Tour Nordik Stone
Wood	Four Seasons Nordik Wood Cozy Flaviker-Dakota Zen
Metal	Rebel
Concrete	Hyper Backstage

Decor & Wall

	Art Walls Flow Chrome
--	-----------------------------

Outdoor

X20 - 20 mm	Supreme Memories Double Rockin' Hyper Blue Savoy Still No_w Rebel Nordik Stone Re_Tour Navona Four Seasons Nordik Wood Cozy Flaviker-Dakota
X30 - 30 mm	Backstage Nordik Stone Rebel Navona Flaviker-Dakota

Technical Information

Naturale

8,5 mm				
40x170	NAT. R.		DK 4713 R	M. 73,50
20x170	NAT. R.		DK 2713 R	M. 73,50
20x120	NAT. R.		DK 2113 R	M. 55,90
	R11. R. RESERVE		DK 2113 S	M. 55,90
30x120	NAT. R.		DK 3113 R	M. 60,50
20x80	NAT. R.		DK 2813 R	M. 46,90
20 mm X20				
30x180	R11 R.	P.TECH	0008915	M. 100,50
30x120	R11 R.	P.TECH	DK 3113 M	M. 87,90
30 mm X30				
30x120	R11 R.	P.TECH	0009240	M. 142,50



Avana

8,5 mm				
40x170	NAT. R.		DK 4730 R	M. 73,50
20x170	NAT. R.		DK 2730 R	M. 73,50
20x120	NAT. R.		DK 2130 R	M. 55,90
	R11. R. RESERVE		DK 2130 S	M. 55,90
30x120	NAT. R.		DK 3130 R	M. 60,50
20x80	NAT. R.		DK 2830 R	M. 46,90
20 mm X20				
30x120	R11 R.	P.TECH	DK 3130 M	M. 87,90



Grigio

8,5 mm				
40x170	NAT. R.		DK 4722 R	M. 73,50
20x170	NAT. R.		DK 2722 R	M. 73,50
20x120	NAT. R.		DK 2122 R	M. 55,90
	R11. R. RESERVE		DK 2122 S	M. 55,90
30x120	NAT. R.		DK 3122 R	M. 60,50
20x80	NAT. R.		DK 2822 R	M. 46,90



Tortora

8,5 mm				
40x170	NAT. R.		DK 4723 R	M. 73,50
20x170	NAT. R.		DK 2723 R	M. 73,50
20x120	NAT. R.		DK 2123 R	M. 55,90
	R11. R. RESERVE		DK 2123 S	M. 55,90
30x120	NAT. R.		DK 3123 R	M. 60,50
20x80	NAT. R.		DK 2823 R	M. 46,90



Index

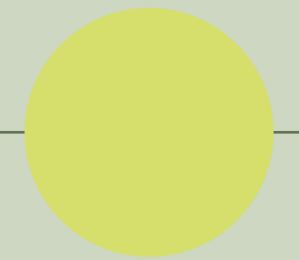

Projects

Marble	Supreme Memories Supreme Treasure Supreme Evo Supreme Classic Navona
Stone	Double Rockin' Blue Savoy Re_Tour Nordik Stone
Wood	Four Seasons Nordik Wood Cozy Flaviker-Dakota Zen
Metal	Rebel
Concrete	Hyper Backstage

Decor & Wall

Art Walls Flow Chrome

Outdoor

X20 - 20 mm	Supreme Memories Double Rockin' Hyper Blue Savoy Still No_w Rebel Nordik Stone Re_Tour Navona Four Seasons Nordik Wood Cozy Flaviker-Dakota
X30 - 30 mm	Backstage Nordik Stone Rebel Navona Flaviker-Dakota

Technical Information



Decor
e Pezzi Speciali
Decors
and Special Trims

	Naturale	Avana	Grigio	Tortora	
8,5 mm Listellato 3D 20x80 NAT RETT.	DK MD 132	-	DK MD 222	-	M. 228,90
8,5 mm Mosaico 30x30 NAT RETT.	DK MO 13M	DK MO 30M	DK MO 22M	DK MO 23M	M. 119,50
8,5 mm Battiscopa 6,5x80 NAT RETT.	DK BN 139	DK BN 309	DK BN 229	DK BN 239	P. 9,90
8,5 mm Battiscopa 6,5x120 NAT RETT.	DK BN 132	DK BN 302	DK BN 222	DK BN 232	P. 11,50
8,5 mm Elemento Elle Reserve 15x60x4 R11 RETT.	DK EN 136	DK EN 306	DK EN 226	DK EN 236	P. 53,50
8,5 mm Gradone Top 32x120x4,5x2 NAT RETT.	DK RT 132 A	DK RT 302 A	DK RT 222 A	DK RT 232 A	P. 194,50
8,5 mm Angolare Top SX 32x120x4,5x2 NAT RETT.	DK RA 13S	DK RA 30S	DK RA 22S	DK RA 23S	P. 225,50
8,5 mm Angolare Top DX 32x120x4,5x2 NAT RETT.	DK RA 13D	DK RA 30D	DK RA 22D	DK RA 23D	P. 225,50



5x120
DK DP 131
LIST. NATURALE RESERVE
P. 9,90



5x120
DK DP 301
LIST. AVANA RESERVE
P. 9,90



5x120
DK DP 231
LIST. TORTORA RESERVE
P. 9,90



6x30
DK DF 131
FASCIA NATURALE
P. 15,50



6x30
DK DF 301
FASCIA AVANA
P. 15,50



6x30
DK DF 231
FASCIA TORTORA
P. 15,50

GRES PORCELLANATO A MASSA COLORATA
FULL BODY COLORED PORCELAIN

CLASSIFICAZIONE SECONDO NORME EN 14411 (ISO 13006) ALLEGATO G GRUPPO B1a GL
CLASSIFICATION IN ACCORDANCE WITH EN 14411 (ISO 13006) ANNEX G GROUP B1a GL



PROPRIETÀ FISICO-CHIMICHE PHYSICAL-CHEMICAL PROPERTIES	NORMA NORM	VALORE PRESCRITTO DALLE NORME VALUE PRESCRIBED FROM THE NORMS	* VAL. / VALUE FLAVIKER NAT.	* VAL. / VALUE FLAVIKER R11 P. TECH
RESISTENZA ALLO SCIVOLAMENTO SLIP RESISTANCE	B.C.R.A. C.A.	<small> a PERICOLOSA - DANGEROUSLY SLIPPERY 0,20 < μ < 0,39 SCIVOLOSITÀ ECCESSIVA - EXCESSIVELY SLIPPERY 0,40 < μ < 0,74 ATTRITO SODDISFACENTE - SATISFACTORY GRIP μ 0,75 ATTRITO ECCELLENTE - EXCELLENT GRIP </small>	> 0,40	> 0,40
	B.C.R.A. G.B.		> 0,40	> 0,40
	ASTM C 1028 (S.C.O.F.)	SLIP RESISTANT (> 0,60)	> 0,60 DRY > 0,60 WET	> 0,60 DRY > 0,60 WET
	DIN 51130	IN FUNZIONE DELL'AMBIENTE O DELLA ZONA DI LAVORO BASING ON THE ENVIRONMENT OR THE WORKING AREA	R10	R11
	DIN 51097	-	A+B	A+B+C
	ANSI A 137-1:2012 (D.C.O.F.)	> 0,42	> 0,42	> 0,42

*Valori medi di produzione / Average production values

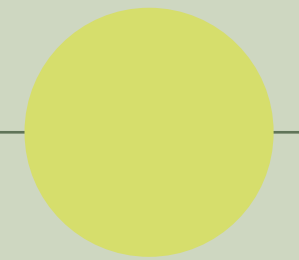

Projects

Marble	Supreme Memories Supreme Treasure Supreme Evo Supreme Classic Navona
Stone	Double Rockin' Blue Savoy Re_Tour Nordik Stone
Wood	Four Seasons Nordik Wood Cozy Flaviker-Dakota Zen
Metal	Rebel
Concrete	Hyper Backstage

Decor & Wall

	Art Walls Flow Chrome
--	-----------------------------

Outdoor

X20 - 20 mm	Supreme Memories Double Rockin' Hyper Blue Savoy Still No_w Rebel Nordik Stone Re_Tour Navona Four Seasons Nordik Wood Cozy Flaviker-Dakota
X30 - 30 mm	Backstage Nordik Stone Rebel Navona Flaviker-Dakota

Technical Information



+
Zen

Gres porcellanato a massa colorata
Full body colored porcelain

Formati

Sizes

8,5 mm
20x120 nat



Bone



Honey



Camel



Oak

+
Zen
Oak
20x120

Index

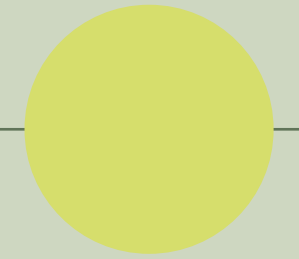

Projects

Marble	Supreme Memories Supreme Treasure Supreme Evo Supreme Classic Navona
Stone	Double Rockin' Blue Savoy Re_Tour Nordik Stone
Wood	Four Seasons Nordik Wood Cozy Flaviker-Dakota Zen
Metal	Rebel
Concrete	Hyper Backstage

Decor & Wall

	Art Walls Flow Chrome
--	-----------------------------

Outdoor

X20 - 20 mm	Supreme Memories Double Rockin' Hyper Blue Savoy Still No_w Rebel Nordik Stone Re_Tour Navona Four Seasons Nordik Wood Cozy Flaviker-Dakota
X30 - 30 mm	Backstage Nordik Stone Rebel Navona Flaviker-Dakota

Technical Information



+
 Zen
 Honey
 20x120

Wood

Bone

8,5 mm
 20x120 NAT. R. 0004938 M. 55,90



Honey

8,5 mm
 20x120 NAT. R. 0004939 M. 55,90



Index

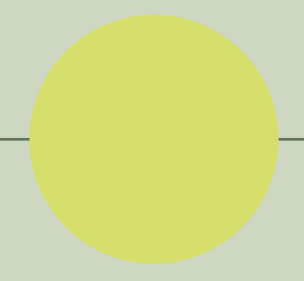

Projects

Marble	Supreme Memories Supreme Treasure Supreme Evo Supreme Classic Navona
Stone	Double Rockin' Blue Savoy Re_Tour Nordik Stone
Wood	Four Seasons Nordik Wood Cozy Flaviker-Dakota Zen
Metal	Rebel
Concrete	Hyper Backstage

Decor & Wall

	Art Walls Flow Chrome
--	-----------------------------

Outdoor

X20 - 20 mm	Supreme Memories Double Rockin' Hyper Blue Savoy Still No_w Rebel Nordik Stone Re_Tour Navona Four Seasons Nordik Wood Cozy Flaviker-Dakota
X30 - 30 mm	Backstage Nordik Stone Rebel Navona Flaviker-Dakota

Technical Information

Camel

8,5 mm
20x120 NAT. R. 0004940 M. 55,90



Oak

8,5 mm
20x120 NAT. R. 0004941 M. 55,90



Decor e Pezzi Speciali Decors and Special Trims		Bone	Honey	Camel	Oak	
	Battiscopa 6,5x120 8,5 mm	NAT. RETT.	0004946	0004947	0004948	0004949 P. 11,50

GRES PORCELLANATO A MASSA COLORATA
FULL BODY COLORED PORCELAIN

CLASSIFICAZIONE SECONDO NORME EN 14411 (ISO 13006) ALLEGATO G GRUPPO B1a GL
CLASSIFICATION IN ACCORDANCE WITH EN 14411 (ISO 13006) ANNEX G GROUP B1a GL

PROPRIETÀ FISICO-CHIMICHE PHYSICAL-CHEMICAL PROPERTIES	NORMA NORM	VALORE PRESCRITTO DALLE NORME VALUE PRESCRIBED FROM THE NORMS	* VAL. / VALUE FLAVIKER NAT.
RESISTENZA ALLO SCIVOLAMENTO SLIP RESISTANCE	B.C.R.A. C.A.	a PERICOLOSA - DANGEROUSLY SLIPPERY 0,20 < μ < 0,39 SCIVOLOSITÀ ECCESSIVA - EXCESSIVELY SLIPPERY 0,40 < μ < 0,74 ATTRITO SODDISFACENTE - SATISFACTORY GRIP μ 0,75 ATTRITO ECCELLENTE - EXCELLENT GRIP	> 0,40
	B.C.R.A. G.B.		> 0,40
	ASTM C 1028 (S.C.O.F.)	SLIP RESISTANT (> 0,60)	> 0,60 DRY > 0,60 WET
	DIN 51130	IN FUNZIONE DELL'AMBIENTE O DELLA ZONA DI LAVORO BASING ON THE ENVIRONMENT OR THE WORKING AREA	R10
	DIN 51097	-	A+B
	ANSI A 137-1:2012 (D.C.O.F.)	> 0,42	> 0,42

*Valori medi di produzione / Average production values

Index

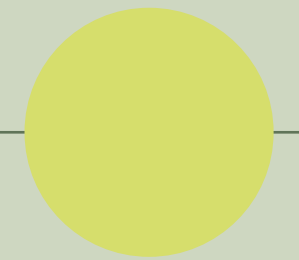

Projects

Marble	Supreme Memories Supreme Treasure Supreme Evo Supreme Classic Navona
Stone	Double Rockin' Blue Savoy Re_Tour Nordik Stone
Wood	Four Seasons Nordik Wood Cozy Flaviker-Dakota Zen
Metal	Rebel
Concrete	Hyper Backstage

Decor & Wall

	Art Walls Flow Chrome
--	-----------------------------

Outdoor

X20 - 20 mm	Supreme Memories Double Rockin' Hyper Blue Savoy Still No_w Rebel Nordik Stone Re_Tour Navona Four Seasons Nordik Wood Cozy Flaviker-Dakota
X30 - 30 mm	Backstage Nordik Stone Rebel Navona Flaviker-Dakota

Technical Information



+
Rebel
Emerald
60x120

Metal



Rebel

Gres porcellanato tutta massa **UGL**

Full body porcelain **UGL**

P. tech

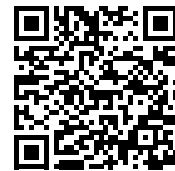

Complete Collection

Formati

Sizes

6 mm

160x320 nat

120x280 nat

8,5 mm

120x120 nat

60x120 nat

80x80 nat

60x60 nat

30x60 nat

20 mm X20

90x90 R11

30 mm X30

60x60 R11



Bronze



Emerald



Lead



Brass



Night



White



Silver

Index

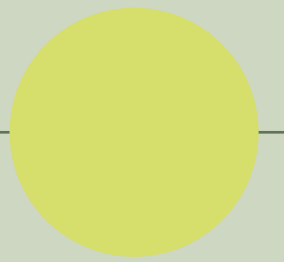

Projects

Marble	Supreme Memories Supreme Treasure Supreme Evo Supreme Classic Navona
Stone	Double Rockin' Blue Savoy Re_Tour Nordik Stone
Wood	Four Seasons Nordik Wood Cozy Flaviker-Dakota Zen
Metal	Rebel
Concrete	Hyper Backstage

Decor & Wall

Art Walls Flow Chrome

Outdoor

X20 - 20 mm	Supreme Memories Double Rockin' Hyper Blue Savoy Still No_w Rebel Nordik Stone Re_Tour Navona Four Seasons Nordik Wood Cozy Flaviker-Dakota
X30 - 30 mm	Backstage Nordik Stone Rebel Navona Flaviker-Dakota

Technical Information



Rebel



Bronze Lead Night Silver White Emerald Brass

Thickness	Dimensions	Finish	Bronze	Lead	Night	Silver	White	Emerald	Brass
6 mm	160x320 64"x128"	NAT RETT.	•						
	120x280 48"x112"	NAT RETT.	•	•	•	•	•	•	
8,5 mm	120x120 48"x48"	NAT RETT.	•	•	•	•	•	•	•
	60x120 24"x48"	NAT RETT.	•	•	•	•	•	•	•
	80x80 32"x32"	NAT RETT.	•	•	•	•	•		
	60x60 24"x24"	NAT RETT.	•	•	•	•	•	•	
20 mm	30x60 12"x24"	NAT RETT.	•	•	•	•	•		
	90x90 36"x36"	R11 RETT. P. TECH	•	•		•			
30 mm	60x60 24"x24"	R11 RETT.				•			

Projects

Material	Projects
Marble	Supreme Memories Supreme Treasure Supreme Evo Supreme Classic Navona
Stone	Double Rockin' Blue Savoy Re_Tour Nordik Stone
Wood	Four Seasons Nordik Wood Cozy Flaviker-Dakota Zen
Metal	Rebel
Concrete	Hyper Backstage

Decor & Wall

Art Walls Flow Chrome

Outdoor

Thickness	Projects
X20 - 20 mm	Supreme Memories Double Rockin' Hyper Blue Savoy Still No_w Rebel Nordik Stone Re_Tour Navona Four Seasons Nordik Wood Cozy Flaviker-Dakota
X30 - 30 mm	Backstage Nordik Stone Rebel Navona Flaviker-Dakota

Technical Information

Bronze

6 mm				
160x320	NAT. R.	0003963	M.	126,50
120x280	NAT. R.	0008666	M.	101,90

8,5 mm				
120x120	NAT. R.	0003758	M.	80,50
60x120	NAT. R.	0004046	M.	61,90
80x80	NAT. R.	0004060	M.	55,90
60x60	NAT. R.	0004095	M.	51,50
30x60	NAT. R.	0004100	M.	46,90

20 mm X20				
90x90	R11 R.	P.TECH	0004251	M. 91,50



182 **X20** Per la serie completa vedi pag.: 238 / For the complete collection see at page: 238
X30 Per la serie completa vedi pag.: 251 / For the complete collection see at page: 251

Lead

6 mm				
120x280	NAT. R.	0008668	M.	101,90

8,5 mm				
120x120	NAT. R.	0003760	M.	80,50
60x120	NAT. R.	0004048	M.	61,90
80x80	NAT. R.	0004062	M.	55,90
60x60	NAT. R.	0004097	M.	51,50
30x60	NAT. R.	0004102	M.	46,90

20 mm X20				
90x90	R11 R.	P.TECH	0004252	M. 91,50



Night

6 mm				
120x280	NAT. R.	0008667	M.	101,90

8,5 mm				
120x120	NAT. R.	0003759	M.	80,50
60x120	NAT. R.	0004047	M.	61,90
80x80	NAT. R.	0004061	M.	55,90
60x60	NAT. R.	0004096	M.	51,50
30x60	NAT. R.	0004101	M.	46,90



183 **X20** Per la serie completa vedi pag.: 238 / For the complete collection see at page: 238
X30 Per la serie completa vedi pag.: 251 / For the complete collection see at page: 251

Silver

6 mm				
120x280	NAT. R.	0008669	M.	101,90

8,5 mm				
120x120	NAT. R.	0003761	M.	80,50
60x120	NAT. R.	0004049	M.	61,90
80x80	NAT. R.	0004063	M.	55,90
60x60	NAT. R.	0004098	M.	51,50
30x60	NAT. R.	0004103	M.	46,90

20 mm X20				
90x90	R11 R.	P.TECH	0004253	M. 91,50

30 mm X30				
60x60	R11 R.	P.TECH	0009238	M. 120,50



183

Index



Projects

Marble	Supreme Memories Supreme Treasure Supreme Evo Supreme Classic Navona
Stone	Double Rockin' Blue Savoy Re_Tour Nordik Stone
Wood	Four Seasons Nordik Wood Cozy Flaviker-Dakota Zen
Metal	Rebel
Concrete	Hyper Backstage

Decor & Wall

Art Walls Flow Chrome

Outdoor

X20 - 20 mm	Supreme Memories Double Rockin' Hyper Blue Savoy Still No_w Rebel Nordik Stone Re_Tour Navona Four Seasons Nordik Wood Cozy Flaviker-Dakota
X30 - 30 mm	Backstage Nordik Stone Rebel Navona Flaviker-Dakota

Technical Information

White

6 mm				
120x280	NAT. R.	0008670	M.	101,90
8,5 mm				
120x120	NAT. R.	0003762	M.	80,50
60x120	NAT. R.	0004050	M.	61,90
80x80	NAT. R.	0004064	M.	55,90
60x60	NAT. R.	0004099	M.	51,50
30x60	NAT. R.	0004104	M.	46,90



Emerald

6 mm				
120x280	NAT. R.	0008072	M.	101,90
8,5 mm				
120x120	NAT. R.	0004945	M.	80,50
60x120	NAT. R.	0004052	M.	61,90
60x60	NAT. R.	0010842	M.	51,50



Brass

8,5 mm				
120x120	NAT. R.	0004944	M.	80,50
60x120	NAT. R.	0004051	M.	61,90



30x30 8,5 mm
0004344
MOSAICO TRIS HOT NAT RETT.
M.285,90
4



30x30 8,5 mm
0004343
MOSAICO TRIS COLD NAT RETT.
M.285,90
4

Index

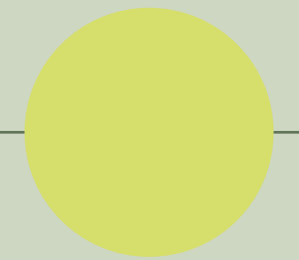

Projects

Marble	Supreme Memories Supreme Treasure Supreme Evo Supreme Classic Navona
Stone	Double Rockin' Blue Savoy Re_Tour Nordik Stone
Wood	Four Seasons Nordik Wood Cozy Flaviker-Dakota Zen
Metal	Rebel
Concrete	Hyper Backstage

Decor & Wall

	Art Walls Flow Chrome
--	-----------------------------

Outdoor

X20 - 20 mm	Supreme Memories Double Rockin' Hyper Blue Savoy Still No_w Rebel Nordik Stone Re_Tour Navona Four Seasons Nordik Wood Cozy Flaviker-Dakota
X30 - 30 mm	Backstage Nordik Stone Rebel Navona Flaviker-Dakota

Technical Information

MATERIA.

Disponibile anche Available also		Bronze	Lead	Night	Silver	White	Emerald	Brass
6 mm 163,5x323	NAT	0003842	-	-	-	-	-	-
12 mm 163,5x323	NAT	0006284	-	0003793	-	-	-	-



Decor
e Pezzi Speciali
Decors
and Special Trims

		Bronze	Lead	Night	Silver	White	Emerald	Brass
8,5 mm	Oblique 25x120	NAT RETT. 0008871	-	0008872	-	-	0008873	-
	2 = 0,46 MQ							M. 235,50
8,5 mm	Mosaico Twist 30x30	NAT RETT. 0008874	-	0008875	-	-	0008876	-
	4							M. 178,50
8,5 mm	Mosaico 30x30	NAT RETT. 0004488	0004490	0004489	0004491	0004492	0004494	0004493
	4							M. 119,50
8,5 mm	Battiscopa 5,5x60	NAT RETT. 0004169	0004171	0004170	0004172	0004173	-	-
	10							P. 7,90
8,5 mm	Battiscopa 5,5x80	NAT RETT. 0004065	0004067	0004066	0004068	0004069	-	-
	8							P. 9,90
8,5 mm	Battiscopa 5,5x120	NAT RETT. 0008564	0008566	0008565	0008567	0008568	0004234	0004233
	6							P. 11,50
8,5 mm	Gradone Top 32x120x4,5x2	NAT RETT. 0004070	0004072	0004071	0004073	0004074	0008574	0008573
	1							P. 194,50
8,5 mm	Angolare Top SX 32x120x4,5x2	NAT RETT. 0004075	0004077	0004076	0004078	0004079	0008572	0008571
	1							P. 225,50
8,5 mm	Angolare Top DX 32x120x4,5x2	NAT RETT. 0004080	0004082	0004081	0004083	0004084	0008570	0008569
	1							P. 225,50

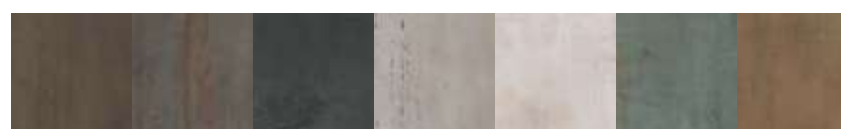

MATITE ALLUMINIO - ALUMINIUM STRIPS

Articoli realizzati in alluminio anodizzato per l'uso a parete, adatti a raccordare piastrelle di diverso spessore (8,5/7/6 mm). Avvertenze per la posa e la pulizia all'interno delle confezioni o sul sito Flaviker.
Anodized Aluminium strips for use between wall tiles of different thicknesses (8,5/7/6 mm). Instructions for installation and cleaning included in the box or on flaviker website.

<p>MATITA ALLUMINIO 0,5X120</p> <p>Parte superiore arrotondata. Rounded top.</p> <p>MATITA ALLUMINIO 0000086 P. 24,50</p>	<p>MATITA ALLUM. WHITE 0000087 P. 32,50</p>
	<p>MATITA ALLUM. TERRACOTTA 0008530 P. 32,50</p>
<p>MATITA ALLUM. BLU 0008532 P. 32,50</p>	<p>MATITA ALLUM. VERDE 0008531 P. 32,50</p>
	<p>MATITA ALLUM. ARDESIA 0008533 P. 32,50</p>
<p>MATITA ALLUM. ORO 0008535 P. 32,50</p>	<p>MATITA ALLUM. BLACK 0000088 P. 32,50</p>
	<p>MATITA ALLUM. RAME SCURO 0008534 P. 32,50</p>

<p>MATITA ALLUMINIO 0,5X120</p> <p>Parte superiore piatta colorata in bagno galvanico. Flat top colored in galvanic bath.</p>	<p>MATITA ALLUM. BRONZO 0000557 P. 40,50</p>
	<p>MATITA ALLUM. RAME 0000556 P. 40,50</p>

GRES PORCELLANATO TUTTA MASSA
FULL BODY PORCELAIN

CLASSIFICAZIONE SECONDO NORME EN 14411 (ISO 13006) ALLEGATO G GRUPPO B1a UGL
CLASSIFICATION IN ACCORDANCE WITH EN 14411 (ISO 13006) ANNEX G GROUP B1a UGL



PROPRIETÀ FISICO-CHIMICHE PHYSICAL-CHEMICAL PROPERTIES	NORMA NORM	VALORE PRESCRITTO DALLE NORME VALUE PRESCRIBED FROM THE NORMS	* VAL. / VALUE FLAVIKER NAT.	* VAL. / VALUE FLAVIKER R11
RESISTENZA ALLO SCIVOLAMENTO SLIP RESISTANCE	B.C.R.A. C.A.	a PERICOLOSA - DANGEROUSLY SLIPPERY 0,20 < μ < 0,39 SCIVOLOSITÀ ECCESSIVA - EXCESSIVELY SLIPPERY 0,40 < μ < 0,74 ATTRITO SODDISFACENTE - SATISFACTORY GRIP μ 0,75 ATTRITO ECCELLENTE - EXCELLENT GRIP	> 0,40 > 0,40	> 0,40 > 0,40
	B.C.R.A. G.B.			
	ASTM C 1028 (S.C.O.F.)	SLIP RESISTANT (> 0,60)	> 0,60 DRY > 0,60 WET	> 0,60 DRY > 0,60 WET
	DIN 51130	IN FUNZIONE DELL'AMBIENTE O DELLA ZONA DI LAVORO BASING ON THE ENVIRONMENT OR THE WORKING AREA	R10	R11
	DIN 51097	-	A+B	A+B+C
	ANSI A 137-1:2012 (D.C.O.F.)	> 0,42	> 0,42	> 0,42

*Valori medi di produzione / Average production values



Projects

Marble	Supreme Memories Supreme Treasure Supreme Evo Supreme Classic Navona
Stone	Double Rockin' Blue Savoy Re_Tour Nordik Stone
Wood	Four Seasons Nordik Wood Cozy Flaviker-Dakota Zen
Metal	Rebel
Concrete	Hyper Backstage

Decor & Wall

Art Walls Flow Chrome

Outdoor

X20 - 20 mm	Supreme Memories Double Rockin' Hyper Blue Savoy Still No_w Rebel Nordik Stone Re_Tour Navona Four Seasons Nordik Wood Cozy Flaviker-Dakota
X30 - 30 mm	Backstage Nordik Stone Rebel Navona Flaviker-Dakota

Technical Information

Multiple Sensations

L'Ufficio Stile Flaviker ha costruito una materioteca in grado di dare vita a molteplici combinazioni. Qui trovi gli abbinamenti più interessanti realizzabili a partire da ciascun colore della gamma Rebel.

Scopri anche i progetti "mix&match" studiati per questa collezione all'interno dell'ambiente bagno.

The Flaviker Style Department has assembled a collection of materials that can be used in many different combinations. Here you'll find the most interesting combinations that can be created using each colour in the Rebel range.

You'll also discover mix&match solutions designed specifically for use of this collection in the bathroom.

BEST
BATHROOM
REBEL



Rebel	Hyper	Re_Tour	Navona	Supreme Treasure / Evo	Four Seasons
Bronze	GREY	ROPE	HONEY	CORCHIA GOLD	BISCUIT
Lead	TAUPE	FOG	GREY	LUMINOUS EVEROSE	BISCUIT
Night	SILVER	FOG	GREY	LASA SAPPHIRE	HONEY
Silver	TAUPE	MUD	GREY	INVISIBLE SELECT	HONEY
White	TAUPE	ROPE	GREY	NOIR LAURENT	BISCUIT
Emerald	SILVER	IVORY	GREY	CALACATTA EMERALD	HONEY
Brass	GREY	MUD	BONE	GREYLAC PLATINUM	CHOCOLATE
	Chrome				
	WHITE				
		BLACK			



Index

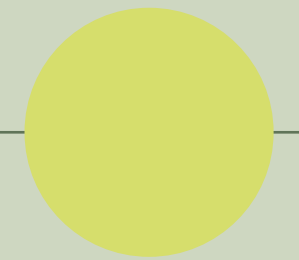

Projects

Marble	Supreme Memories Supreme Treasure Supreme Evo Supreme Classic Navona
Stone	Double Rockin' Blue Savoy Re_Tour Nordik Stone
Wood	Four Seasons Nordik Wood Cozy Flaviker-Dakota Zen
Metal	Rebel
Concrete	Hyper Backstage

Decor & Wall

	Art Walls Flow Chrome
--	-----------------------------

Outdoor

X20 - 20 mm	Supreme Memories Double Rockin' Hyper Blue Savoy Still No_w Rebel Nordik Stone Re_Tour Navona Four Seasons Nordik Wood Cozy Flaviker-Dakota
X30 - 30 mm	Backstage Nordik Stone Rebel Navona Flaviker-Dakota

Technical Information



+
Hyper
Silver
160x320

+
Hyper
Silver
80x80

+
Hyper

Gres porcellanato tutta massa **UGL**
Full body porcelain **UGL**

P. tech



Complete Collection

Formati

Sizes

6 mm		
160x320	nat	
120x280	nat	
8,5 mm		
120x120	nat	
60x120	nat	
80x80	nat	
60x60	nat/R11	
30x60	nat	
20 mm X20		
120x120	R11	
60x120	R11	



Silver



Grey



Taupe

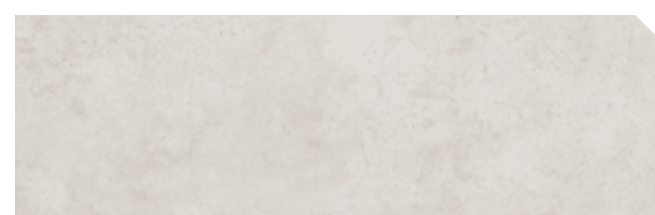

White

Index

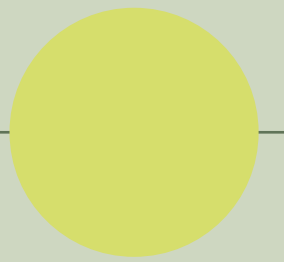

Projects

Marble	Supreme Memories Supreme Treasure Supreme Evo Supreme Classic Navona
Stone	Double Rockin' Blue Savoy Re_Tour Nordik Stone
Wood	Four Seasons Nordik Wood Cozy Flaviker-Dakota Zen
Metal	Rebel
Concrete	Hyper Backstage

Decor & Wall

	Art Walls Flow Chrome
--	-----------------------------

Outdoor

X20 - 20 mm	Supreme Memories Double Rockin' Hyper Blue Savoy Still No_w Rebel Nordik Stone Re_Tour Navona Four Seasons Nordik Wood Cozy Flaviker-Dakota
X30 - 30 mm	Backstage Nordik Stone Rebel Navona Flaviker-Dakota

Technical Information



+
Hyper
Grey
120x280

+
Rebel
Brass
120x120

+
Supreme Treasure
Calacatta Emerald
120x120

+
Hyper
Taupe
120x280

Concrete

Hyper



Silver Grey Taupe White

Thickness	Size	Finish	Silver	Grey	Taupe	White
6 mm	160x320 64"x128"	NAT. RETT.	•			
	120x280 48"x112"	NAT. RETT.	•	•	•	•
8,5 mm	120x120 48"x48"	NAT. RETT.	•	•	•	•
	60x120 24"x48"	NAT. RETT.	•	•	•	•
	80x80 32"x32"	NAT. RETT.	•	•	•	•
	60x60 24"x24"	NAT. RETT.	•	•	•	•
	30x60 12"x24"	NAT. RETT.	•	•	•	•
	60x60 24"x24"	R11 RETT. P3	•	•		
20 mm	120x120 48"x48"	R11 RETT. P. TECH	•			•
	60x120 24"x24"	R11 RETT. P. TECH	•	•	•	

Index

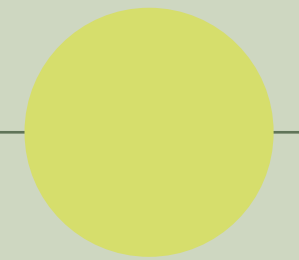

Projects

Material	Projects
Marble	Supreme Memories Supreme Treasure Supreme Evo Supreme Classic Navona
Stone	Double Rockin' Blue Savoy Re_Tour Nordik Stone
Wood	Four Seasons Nordik Wood Cozy Flaviker-Dakota Zen
Metal	Rebel
Concrete	Hyper Backstage

Decor & Wall

Art Walls Flow Chrome

Outdoor

Thickness	Projects
X20 - 20 mm	Supreme Memories Double Rockin' Hyper Blue Savoy Still No_w Rebel Nordik Stone Re_Tour Navona Four Seasons Nordik Wood Cozy Flaviker-Dakota
X30 - 30 mm	Backstage Nordik Stone Rebel Navona Flaviker-Dakota

Technical Information

Silver

6 mm				
160x320	NAT. R.	0002436	M.	126,50
120x280 *	NAT. R.	0008661	M.	101,90

8,5 mm				
120x120	NAT. R.	0002448	M.	80,50
60x120	NAT. R.	0002451	M.	61,90
80x80	NAT. R.	0002457	M.	55,90
60x60	NAT. R.	0003023	M.	51,50
	R11 R.	0003032	M.	51,50
30x60	NAT. R.	0003168	M.	46,90

20 mm	X20			
120x120	R11 R.	P.TECH	0008346	M. 108,50
60x120	R11 R.	P.TECH	0002770	M. 87,90



Grey

6 mm				
120x280 *	NAT. R.	0008079	M.	101,90

8,5 mm				
120x120	NAT. R.	0002449	M.	80,50
60x120	NAT. R.	0002452	M.	61,90
80x80	NAT. R.	0002458	M.	55,90
60x60	NAT. R.	0003024	M.	51,50
	R11 R.	0003033	M.	51,50
30x60	NAT. R.	0003169	M.	46,90

20 mm	X20			
60x120	R11 R.	P.TECH	0002771	M. 87,90



Taupe

6 mm				
120x280 *	NAT. R.	0008080	M.	101,90

8,5 mm				
120x120	NAT. R.	0002450	M.	80,50
60x120	NAT. R.	0002453	M.	61,90
80x80	NAT. R.	0002459	M.	55,90
60x60	NAT. R.	0003025	M.	51,50
30x60	NAT. R.	0003170	M.	46,90

20 mm	X20			
60x120	R11 R.	P.TECH	0002772	M. 87,90



White

6 mm				
120x280 *	NAT. R.	0008662	M.	101,90

8,5 mm				
120x120	NAT. R.	0005714	M.	80,50
60x120	NAT. R.	0005502	M.	61,90
80x80	NAT. R.	0005510	M.	55,90
60x60	NAT. R.	0005722	M.	51,50
30x60	NAT. R.	0005497	M.	46,90

20 mm	X20			
120x120	R11 R.	P.TECH	0008415	M. 108,50



Index



Projects

Marble	Supreme Memories Supreme Treasure Supreme Evo Supreme Classic Navona
Stone	Double Rockin' Blue Savoy Re_Tour Nordik Stone
Wood	Four Seasons Nordik Wood Cozy Flaviker-Dakota Zen
Metal	Rebel
Concrete	Hyper Backstage

Decor & Wall

	Art Walls Flow Chrome
--	-----------------------------

Outdoor

X20 - 20 mm	Supreme Memories Double Rockin' Hyper Blue Savoy Still No_w Rebel Nordik Stone Re_Tour Navona Four Seasons Nordik Wood Cozy Flaviker-Dakota
X30 - 30 mm	Backstage Nordik Stone Rebel Navona Flaviker-Dakota

Technical Information



60x120
0003100
HYPER SILVER PATCH RETT.
M.71,90

Articolo composto da pattern grafici diversi che non prevedono agganci tra loro e miscelati in modo casuale in fase di inscatolamento. Non si garantisce pertanto la presenza costante di tutti i soggetti all'interno delle confezioni. / This article comes in several different versions with unconnected patterns that are mixed randomly at the time of packaging. There is therefore no guarantee that all patterns will be present in any individual box.

8,5 mm

SLIM PACK

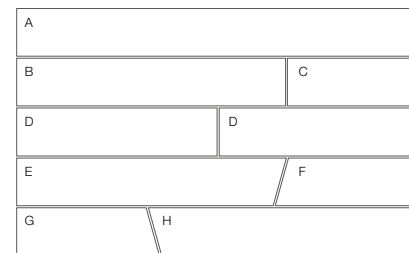

- A** = 4 PZ/BOX - 7,5x60
- B** = 4 PZ/BOX - 7,5x40
- C** = 4 PZ/BOX - 7,5x20
- D** = 4 PZ/BOX - 7,5x30
- E** = 1 PZ/BOX - 7,5x40
- F** = 1 PZ/BOX - 7,5x20
- G** = 1 PZ/BOX - 7,5x20
- H** = 1 PZ/BOX - 7,5x40

ESEMPIO DI POSA (1 SCATOLA = 0,54 mq)
LAYING EXAMPLE (1 BOX = 0,54 sqm)

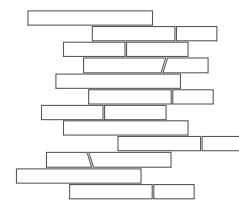

MATERIA.

Disponibile anche
Available also

		Silver	Grey	Taupe	White
6 mm	NAT	0002434	-	-	0005469
12 mm	NAT	0003794	-	-	0006285
20 mm	NAT	-	-	-	0008334



MATITE ALLUMINIO - ALUMINIUM STRIPS

Articoli realizzati in alluminio anodizzato per l'uso a parete, adatti a raccordare piastrelle di diverso spessore (8,5/7/6 mm). Avvertenze per la posa e la pulizia all'interno delle confezioni o sul sito Flaviker. Anodized Aluminium strips for use between wall tiles of different thicknesses (8,5/7/6 mm). Instructions for installation and cleaning included in the box or on flaviker website.

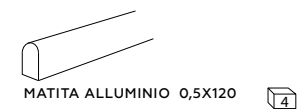

Parte superiore arrotondata. Rounded top.
MATITA ALLUMINIO
0000086 P. 24,50

Parte superiore arrotondata e colorata con resine acriliche.
Rounded top colored with acrylic resins.

MATITA ALLUM. ORO
0008535 P. 32,50

MATITA ALLUM. RAME SCURO
0008534 P. 32,50

MATITA ALLUM. WHITE
0000087 P. 32,50

MATITA ALLUM. TERRACOTTA
0008530 P. 32,50

MATITA ALLUM. BLU
0008532 P. 32,50

MATITA ALLUM. VERDE
0008531 P. 32,50

MATITA ALLUM. ARDESIA
0008533 P. 32,50

MATITA ALLUM. BLACK
0000088 P. 32,50

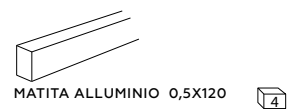

Parte superiore piatta colorata in bagno galvanico.
Flat top colored in galvanic bath.

MATITA ALLUM. BRONZO
0000557 P. 40,50

MATITA ALLUM. RAME
0000556 P. 40,50

		Silver	Grey	Taupe	White		
	Slim Pack 30x60 8,5 mm	NAT RETT.	0003115	0003116	0003117	-	M. 115,90
	Mosaico 30x30 8,5 mm	NAT RETT.	0003658	0003659	0003660	0005720	M. 119,50
	Battiscopa 5,5x60 8,5 mm	NAT RETT.	0003026	0003027	0003028	0005723	P. 7,90
	Battiscopa 5,5x80 8,5 mm	NAT RETT.	0003122	0003123	0003124	0005715	P. 9,90
	Gradone Top 32x120x4,5x2 8,5 mm	NAT RETT.	0003125	0003126	0003127	0005716	P. 194,50
	Angolare Top SX 32x120x4,5x2 8,5 mm	NAT RETT.	0003128	0003129	0003130	0005717	P. 225,50
	Angolare Top DX 32x120x4,5x2 8,5 mm	NAT RETT.	0003131	0003132	0003133	0005718	P. 225,50

GRES PORCELLANATO TUTTA MASSA
FULL BODY PORCELAIN

CLASSIFICAZIONE SECONDO NORME EN 14411 (ISO 13006) ALLEGATO G GRUPPO B1a UGL
CLASSIFICATION IN ACCORDANCE WITH EN 14411 (ISO 13006) ANNEX G GROUP B1a UGL



PROPRIETÀ FISICO-CHIMICHE PHYSICAL-CHEMICAL PROPERTIES	NORMA NORM	VALORE PRESCRITTO DALLE NORME VALUE PRESCRIBED FROM THE NORMS	* VAL. / VALUE FLAVIKER NAT.	* VAL. / VALUE FLAVIKER R11
	B.C.R.A. C.A.	μ PERICOLOSA - DANGEROUSLY SLIPPERY 0,20 < μ < 0,39 SCIVOLosità ECCESSIVA - EXCESSIVELY SLIPPERY 0,40 < μ < 0,74 ATTRITO SODDISFACENTE - SATISFACTORY GRIP μ 0,75 ATTRITO ECCELLENTE - EXCELLENT GRIP	> 0,40	> 0,40
	B.C.R.A. G.B.		> 0,40	> 0,40
RESISTENZA ALLO SCIVOLAMENTO SLIP RESISTANCE	ASTM C 1028 (S.C.O.F.)	SLIP RESISTANT (> 0,60)	> 0,60 DRY > 0,60 WET	> 0,60 DRY > 0,60 WET
	DIN 51130	IN FUNZIONE DELL'AMBIENTE O DELLA ZONA DI LAVORO BASING ON THE ENVIRONMENT OR THE WORKING AREA	R10	R11
	DIN 51097	-	A+B	A+B+C
	ANSI A 137-1:2012 (D.C.O.F.)	> 0,42	> 0,42	> 0,42

*Valori medi di produzione / Average production values

P. tech ON DEMAND

La tecnologia P.TECH migliora le performance anti-scivolo dei pavimenti, mantenendo inalterati i valori di resistenza meccanica del gres porcellanato, con una finitura estremamente piacevole al tatto e facile da pulire. **HYPER in finitura P.TECH, nei formati 120x120, 60x120 e 60x60, può essere fornita su richiesta con un ordine soggetto a lotto minimo di produzione.**

The innovative P.TECH technology which improves the slip resistance of floors while delivering the renowned mechanical strength of porcelain stoneware and a finish that is both extremely pleasant to the touch and easy to clean. **HYPER in P.TECH finish, in the 120x120, 60x120 and 60x60 sizes, can be supplied on request with an order subject to a minimum production batch.**

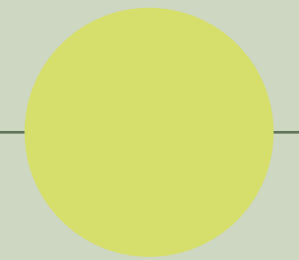

Projects

Marble	Supreme Memories Supreme Treasure Supreme Evo Supreme Classic Navona
Stone	Double Rockin' Blue Savoy Re_Tour Nordik Stone
Wood	Four Seasons Nordik Wood Cozy Flaviker-Dakota Zen
Metal	Rebel
Concrete	Hyper Backstage

Decor & Wall

Art Walls Flow Chrome

Outdoor

X20 - 20 mm	Supreme Memories Double Rockin' Hyper Blue Savoy Still No_w Rebel Nordik Stone Re_Tour Navona Four Seasons Nordik Wood Cozy Flaviker-Dakota
X30 - 30 mm	Backstage Nordik Stone Rebel Navona Flaviker-Dakota

Technical Information

Multiple Sensations

L'Ufficio Stile Flaviker ha costruito una materioteca in grado di dare vita a molteplici combinazioni. Qui trovi gli abbinamenti più interessanti realizzabili a partire da ciascun colore della gamma Hyper.

The Flaviker Style Department has assembled a collection of materials that can be used in many different combinations. Here you'll find the most interesting combinations that can be created using each colour in the Hyper range.



Index

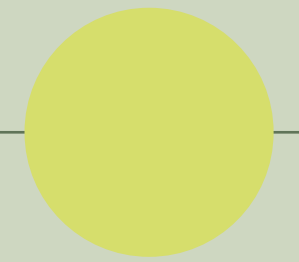

Projects

Marble	Supreme Memories Supreme Treasure Supreme Evo Supreme Classic Navona
Stone	Double Rockin' Blue Savoy Re_Tour Nordik Stone
Wood	Four Seasons Nordik Wood Cozy Flaviker-Dakota Zen
Metal	Rebel
Concrete	Hyper Backstage

Decor & Wall

Art Walls Flow Chrome

Outdoor

X20 - 20 mm	Supreme Memories Double Rockin' Hyper Blue Savoy Still No_w Rebel Nordik Stone Re_Tour Navona Four Seasons Nordik Wood Cozy Flaviker-Dakota
X30 - 30 mm	Backstage Nordik Stone Rebel Navona Flaviker-Dakota

Technical Information



Concrete

+ Backstage

Gres porcellanato a massa colorata
Full body colored porcelain



Complete Collection

Formati

Sizes

8,5 mm	
60x120	nat
80x80	nat
40x80	nat
60x60	nat
20x40	R11
30 mm X30	
90x90	R11



Graphite



Ash

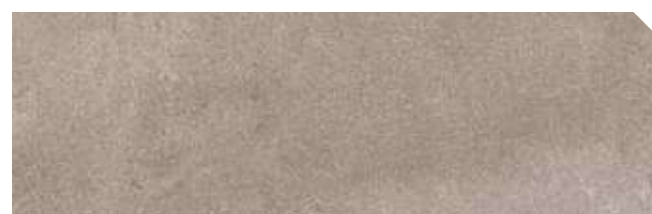

Tan



Bisque

+
Backstage
Ash
60x120

Index



Projects

Marble	Supreme Memories Supreme Treasure Supreme Evo Supreme Classic Navona
Stone	Double Rockin' Blue Savoy Re_Tour Nordik Stone
Wood	Four Seasons Nordik Wood Cozy Flaviker-Dakota Zen
Metal	Rebel
Concrete	Hyper Backstage

Decor & Wall

Art Walls Flow Chrome

Outdoor

X20 - 20 mm	Supreme Memories Double Rockin' Hyper Blue Savoy Still No_w Rebel Nordik Stone Re_Tour Navona Four Seasons Nordik Wood Cozy Flaviker-Dakota
X30 - 30 mm	Backstage Nordik Stone Rebel Navona Flaviker-Dakota

Technical Information



Graphite Ash Tan Bisque

8,5 mm	60x120 24"x48"	NAT. RETT.	•	•	•	•
	80x80 24"x48"	NAT. RETT.	•	•	•	
	40x80 16"x32"	NAT. RETT.	•	•	•	•
	60x60 24"x24"	NAT. RETT.	•	•	•	•
	20x40 8"x16"	STRUTT. R11 NAT.		•	•	
30 mm	90x90 36"x36"	R11 RETT.	•	•		

Graphite

8,5 mm				
60x120	NAT. R.	BK6123R	M.	60,50
80x80	NAT. R.	0003049	M.	54,90
40x80	NAT. R.	BK4823R	M.	48,50
60x60	NAT. R.	BK6023R	M.	48,90
30 mm				
90x90	X30 R11 R.	0009235	M.	142,50

Ash

8,5 mm				
60x120	NAT. R.	BK6122R	M.	60,50
80x80	NAT. R.	0003047	M.	54,90
40x80	NAT. R.	BK4822R	M.	48,50
60x60	NAT. R.	BK6022R	M.	48,90
20x40	R11 N. STRUTT.	BK2422	M.	36,90
30 mm				
90x90	X30 R11 R.	0009236	M.	142,50



Schemi di posa Installation patterns

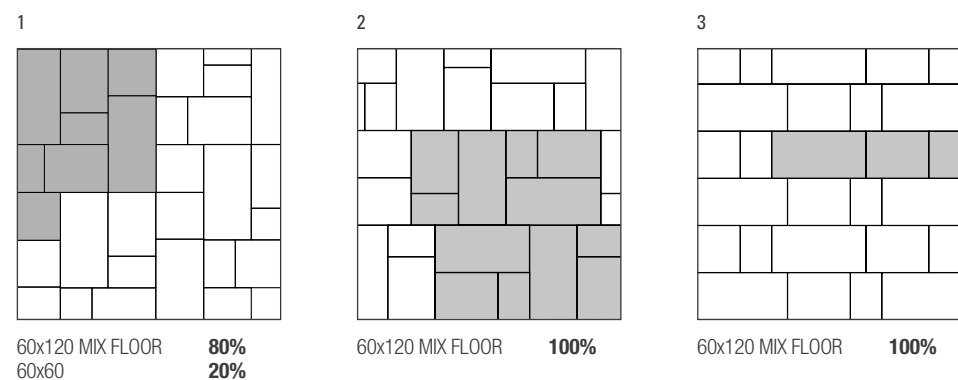

Index



Projects

Marble	Supreme Memories Supreme Treasure Supreme Evo Supreme Classic Navona
Stone	Double Rockin' Blue Savoy Re_Tour Nordik Stone
Wood	Four Seasons Nordik Wood Cozy Flaviker-Dakota Zen
Metal	Rebel
Concrete	Hyper Backstage

Decor & Wall

Art Walls Flow Chrome

Outdoor

X20 - 20 mm	Supreme Memories Double Rockin' Hyper Blue Savoy Still No_w Rebel Nordik Stone Re_Tour Navona Four Seasons Nordik Wood Cozy Flaviker-Dakota
X30 - 30 mm	Backstage Nordik Stone Rebel Navona Flaviker-Dakota

Technical Information

Tan

8,5 mm				
60x120	NAT. R.	BK6130R	M. 60,50	
80x80	NAT. R.	0003048	M. 54,90	
40x80	NAT. R.	BK4830R	M. 48,50	
60x60	NAT. R.	BK6030R	M. 48,90	
20x40	R11 N. STRUTT.	BK2430	M. 36,90	



Bisque

8,5 mm				
60x120	NAT. R.	BK6113R	M. 60,50	
40x80	NAT. R.	BK4813R	M. 48,50	
60x60	NAT. R.	BK6013R	M. 48,90	



Decorie Pezzi Speciali
Decors and Special Trims

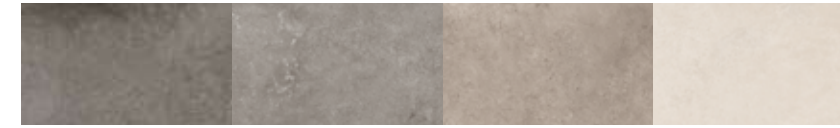

			Graphite	Ash	Tan	Bisque	
	Mosaico 30x30	NAT RETT.	BK MO 231	BK MO 221	BK MO 301	BK MO 131	M. 119,50
	Mosaico Hexagon 51x29,2	NAT RETT.	BK ES 23 R	BK ES 22 R	BK ES 30 R	BK ES 13 R	M. 138,50
	Mix Floor 60x120	1pz NAT RETT.	BK FLO 23	BK FLO 22	BK FLO 30	BK FLO 13	M. 90,90
	60x80	1pz					
	60x40	1pz					
	Mix Sizes 40x80	3pz NAT RETT.	BK MIX 23	BK MIX 22	BK MIX 30	BK MIX 13	M. 72,90
	13,5x80	3pz					
	6,5x80	3pz					
	Battiscopa 5,5x60	NAT RETT.	BK BN 236A	BK BN 226A	BK BN 306A	BK BN 136A	P. 7,90
	Gradone Top 32x120x4,5x2	NAT RETT.	BK RT 232A	BK RT 222A	BK RT 302A	BK RT 132A	P. 194,50
	Angolare Top SX 32x120x4,5x2	NAT RETT.	BK RA 23S	BK RA 22S	BK RA 30S	BK RA 13S	P. 225,50
	Angolare Top DX 32x120x4,5x2	NAT RETT.	BK RA 23D	BK RA 22D	BK RA 30D	BK RA 13D	P. 225,50
	Elem. Monolitico 15x30x3,5	NAT	-	BK EN 223	BK EN 303	-	P. 20,50

GRES PORCELLANATO MASSA COLORATA
FULL BODY COLORED PORCELAIN

CLASSIFICAZIONE SECONDO NORME EN 14411 (ISO 13006) ALLEGATO G GRUPPO BIa GL
CLASSIFICATION IN ACCORDANCE WITH EN 14411 (ISO 13006) ANNEX G GROUP BIa GL



PROPRIETÀ FISICO-CHIMICHE PHYSICAL-CHEMICAL PROPERTIES	NORMA NORM	VALORE PRESCRITTO DALLE NORME VALUE PRESCRIBED FROM THE NORMS	* VAL. / VALUE FLAVIKER NAT.	* VAL. / VALUE FLAVIKER R11
	B.C.R.A. C.A.	a PERICOLOSA - DANGEROUSLY SLIPPERY 0,20 < μ < 0,39 SCIVOLosità ECCESSIVA - EXCESSIVELY SLIPPERY 0,40 < μ < 0,74 ATTRITO SODDISFACENTE - SATISFACTORY GRIP μ 0,75 ATTRITO ECCELLENTE - EXCELLENT GRIP	> 0,40	> 0,40
	B.C.R.A. G.B.		> 0,40	> 0,40
RESISTENZA ALLO SCIVOLAMENTO SLIP RESISTANCE	ASTM C 1028 (S.C.O.F.)	SLIP RESISTANT (> 0,60)	> 0,60 DRY > 0,60 WET	> 0,60 DRY > 0,60 WET
	DIN 51130	IN FUNZIONE DELL'AMBIENTE O DELLA ZONA DI LAVORO BASING ON THE ENVIRONMENT OR THE WORKING AREA	R10	R11
	DIN 51097	-	A+B	A+B+C
	ANSI A 137-1:2012 (D.C.O.F.)	> 0,42	> 0,42	> 0,42

*Valori medi di produzione / Average production values

Index

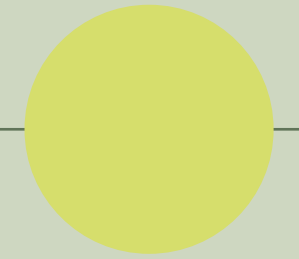

Projects

Material	Projects
Marble	Supreme Memories Supreme Treasure Supreme Evo Supreme Classic Navona
Stone	Double Rockin' Blue Savoy Re_Tour Nordik Stone
Wood	Four Seasons Nordik Wood Cozy Flaviker-Dakota Zen
Metal	Rebel
Concrete	Hyper Backstage

Decor & Wall

Art Walls Flow Chrome

Outdoor

X20 - 20 mm	Projects
X20 - 20 mm	Supreme Memories Double Rockin' Hyper Blue Savoy Still No_w Rebel Nordik Stone Re_Tour Navona Four Seasons Nordik Wood Cozy Flaviker-Dakota
X30 - 30 mm	Projects
X30 - 30 mm	Backstage Nordik Stone Rebel Navona Flaviker-Dakota

Technical Information

+

Decor & Wall

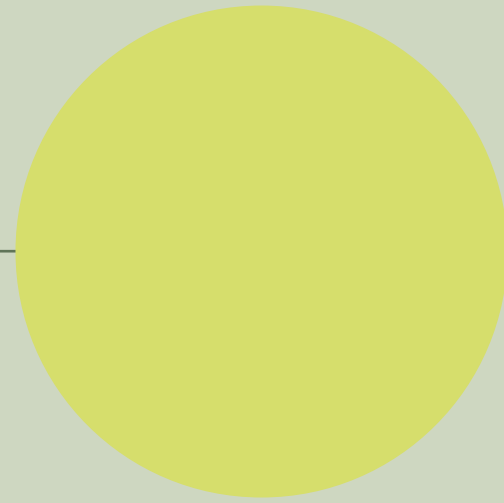

Art Walls	208
Flow	222
Chrome	226

Index

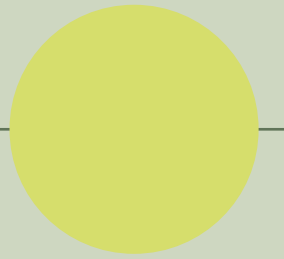

Projects

Marble	Supreme Memories Supreme Treasure Supreme Evo Supreme Classic Navona
Stone	Double Rockin' Blue Savoy Re_Tour Nordik Stone
Wood	Four Seasons Nordik Wood Cozy Flaviker-Dakota Zen
Metal	Rebel
Concrete	Hyper Backstage

Decor & Wall

	Art Walls Flow Chrome
--	-----------------------------

Outdoor

X20 - 20 mm	Supreme Memories Double Rockin' Hyper Blue Savoy Still No_w Rebel Nordik Stone Re_Tour Navona Four Seasons Nordik Wood Cozy Flaviker-Dakota
X30 - 30 mm	Backstage Nordik Stone Rebel Navona Flaviker-Dakota

Technical Information



+ Art Walls

Gres porcellanato
Porcelain tiles

Formati

Sizes

6 mm
120x280 nat/lux/soft
60x120 nat/lux

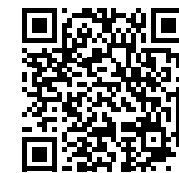

Complete Collection



Tapis



Frost



Drape



Metal



Beyond



Degradè



Dripping



Glass



Fresco



Shadow



Landscape

Index

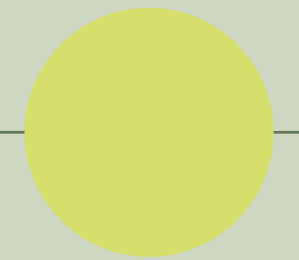

Projects

Marble	Supreme Memories Supreme Treasure Supreme Evo Supreme Classic Navona
Stone	Double Rockin' Blue Savoy Re_Tour Nordik Stone
Wood	Four Seasons Nordik Wood Cozy Flaviker-Dakota Zen
Metal	Rebel
Concrete	Hyper Backstage

Decor & Wall

Art Walls
Flow
Chrome

Outdoor

X20 - 20 mm	Supreme Memories Double Rockin' Hyper Blue Savoy Still No_w Rebel Nordik Stone Re_Tour Navona Four Seasons Nordik Wood Cozy Flaviker-Dakota
X30 - 30 mm	Backstage Nordik Stone Rebel Navona Flaviker-Dakota

Technical Information



Art Walls
Tapis
120x280

+ Art Walls

Decor & Wall

Tapis

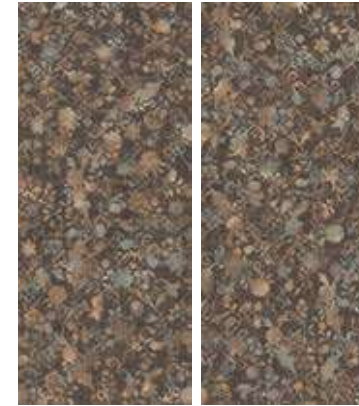

120x280
6 mm NAT. R. 0014135 * M. 152,90



60x120
6 mm NAT. R. 0014664 ** M. 91,90

* Articolo composto da 2 pattern grafici diversi miscelati in modo casuale. Non si garantisce pertanto la presenza costante di tutti i soggetti.
This item is produced with 2 different graphic patterns, randomly packed and delivered.

Ripresa grafica tra le due lastre contenuta entro una tolleranza di 3 cm.
Graphic clearance among the two slabs ranging within 3 cm.

** Articolo composto da pattern grafici diversi che non prevedono agganci tra loro e miscelati in modo casuale. Non si garantisce pertanto la presenza costante di tutti i soggetti.
This item is produced with different graphic patterns, randomly packed and delivered.

Index

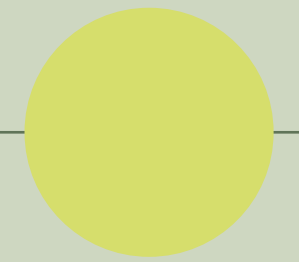

Projects

Marble	Supreme Memories Supreme Treasure Supreme Evo Supreme Classic Navona
Stone	Double Rockin' Blue Savoy Re_Tour Nordik Stone
Wood	Four Seasons Nordik Wood Cozy Flaviker-Dakota Zen
Metal	Rebel
Concrete	Hyper Backstage

Decor & Wall

Art Walls
Flow
Chrome

Outdoor

X20 - 20 mm	Supreme Memories Double Rockin' Hyper Blue Savoy Still No_w Rebel Nordik Stone Re_Tour Navona Four Seasons Nordik Wood Cozy Flaviker-Dakota
X30 - 30 mm	Backstage Nordik Stone Rebel Navona Flaviker-Dakota

Technical Information

Frost



120x280
6 mm LUX RETT. **0014138 *** M. 183,50



60x120
6 mm LUX RETT. **0014665 **** M. 112,90

* Articolo composto da 2 pattern grafici diversi che non prevedono agganci tra loro e miscelati in modo casuale. Non si garantisce pertanto la presenza costante di tutti i soggetti.
This item is produced with 2 different graphic patterns, randomly packed and delivered.

** Articolo composto da pattern grafici diversi che non prevedono agganci tra loro e miscelati in modo casuale. Non si garantisce pertanto la presenza costante di tutti i soggetti.
This item is produced with different graphic patterns, randomly packed and delivered.

Drape



120x280
6 mm SLAB A SOFT RETT. **0014136** M. 183,50



120x280
6 mm SLAB B SOFT RETT. **0014137** M. 183,50

Ripresa grafica tra le due lastre contenuta entro una tolleranza di 3 cm.
Graphic clearance among the two slabs ranging within 3 cm.

Index



Projects

Marble	Supreme Memories Supreme Treasure Supreme Evo Supreme Classic Navona
Stone	Double Rockin' Blue Savoy Re_Tour Nordik Stone
Wood	Four Seasons Nordik Wood Cozy Flaviker-Dakota Zen
Metal	Rebel
Concrete	Hyper Backstage

Decor & Wall

Art Walls
Flow
Chrome

Outdoor

X20 - 20 mm	Supreme Memories Double Rockin' Hyper Blue Savoy Still No_w Rebel Nordik Stone Re_Tour Navona Four Seasons Nordik Wood Cozy Flaviker-Dakota
X30 - 30 mm	Backstage Nordik Stone Rebel Navona Flaviker-Dakota

Technical Information

Metal



120x280
6 mm NAT. RETT. **0014134 *** M. 152,90

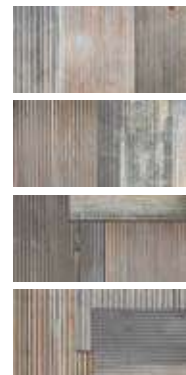

60x120
6 mm NAT. RETT. **0014663 **** M. 91,90

* Articolo composto da 2 pattern grafici diversi che non prevedono agganci tra loro e miscelati in modo casuale. Non si garantisce pertanto la presenza costante di tutti i soggetti.
This item is produced with 2 different graphic patterns, randomly packed and delivered.

** Articolo composto da pattern grafici diversi che non prevedono agganci tra loro e miscelati in modo casuale. Non si garantisce pertanto la presenza costante di tutti i soggetti.
This item is produced with different graphic patterns, randomly packed and delivered.

Beyond



120x280
6 mm LUX RETT. **0010092 *** M. 183,50



60x120
6 mm LUX RETT. **0012584 **** M. 112,90

* Articolo composto da 2 pattern grafici diversi che non prevedono agganci tra loro e miscelati in modo casuale. Non si garantisce pertanto la presenza costante di tutti i soggetti.
This item is produced with 2 different graphic patterns, randomly packed and delivered.

** Articolo composto da pattern grafici diversi che non prevedono agganci tra loro e miscelati in modo casuale. Non si garantisce pertanto la presenza costante di tutti i soggetti.
This item is produced with different graphic patterns, randomly packed and delivered.

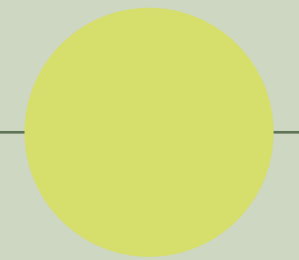

Projects

Marble	Supreme Memories Supreme Treasure Supreme Evo Supreme Classic Navona
Stone	Double Rockin' Blue Savoy Re_Tour Nordik Stone
Wood	Four Seasons Nordik Wood Cozy Flaviker-Dakota Zen
Metal	Rebel
Concrete	Hyper Backstage

Decor & Wall

Art Walls
Flow
Chrome

Outdoor

X20 - 20 mm	Supreme Memories Double Rockin' Hyper Blue Savoy Still No_w Rebel Nordik Stone Re_Tour Navona Four Seasons Nordik Wood Cozy Flaviker-Dakota
X30 - 30 mm	Backstage Nordik Stone Rebel Navona Flaviker-Dakota

Technical Information

Degradè



120x280
6 mm LUX RETT. 0010091 * M. 183,50

* Articolo composto da 2 pattern grafici diversi che non prevedono agganci tra loro e miscelati in modo casuale. Non si garantisce pertanto la presenza costante di tutti i soggetti.
This item is produced with 2 different graphic patterns, randomly packed and delivered.

Dripping



120x280
6 mm LUX RETT. 0010571 * M. 183,50



60x120
6 mm LUX RETT. 0012586 ** M. 112,90

* Articolo composto da 2 pattern grafici diversi che non prevedono agganci tra loro e miscelati in modo casuale. Non si garantisce pertanto la presenza costante di tutti i soggetti.
This item is produced with 2 different graphic patterns, randomly packed and delivered.

** Articolo composto da pattern grafici diversi che non prevedono agganci tra loro e miscelati in modo casuale. Non si garantisce pertanto la presenza costante di tutti i soggetti.
This item is produced with different graphic patterns, randomly packed and delivered.

Index



Projects

Marble	Supreme Memories Supreme Treasure Supreme Evo Supreme Classic Navona
Stone	Double Rockin' Blue Savoy Re_Tour Nordik Stone
Wood	Four Seasons Nordik Wood Cozy Flaviker-Dakota Zen
Metal	Rebel
Concrete	Hyper Backstage

Decor & Wall

Art Walls
Flow
Chrome

Outdoor

X20 - 20 mm	Supreme Memories Double Rockin' Hyper Blue Savoy Still No_w Rebel Nordik Stone Re_Tour Navona Four Seasons Nordik Wood Cozy Flaviker-Dakota
X30 - 30 mm	Backstage Nordik Stone Rebel Navona Flaviker-Dakota

Technical Information

Glass



120x280
6 mm LUX RETT. **0010570** M. 183,50



60x120
6 mm LUX RETT. **0012585 **** M. 112,90

** Articolo composto da pattern grafici diversi che non prevedono agganci tra loro e miscelati in modo casuale. Non si garantisce pertanto la presenza costante di tutti i soggetti.
This item is produced with different graphic patterns, randomly packed and delivered.

Fresco



120x280
6 mm NAT. RETT. **0010090 *** M. 152,90



60x120
6 mm NAT. RETT. **0012583 **** M. 91,90

* Articolo composto da 2 pattern grafici diversi che non prevedono agganci tra loro e miscelati in modo casuale. Non si garantisce pertanto la presenza costante di tutti i soggetti.
This item is produced with 2 different graphic patterns, randomly packed and delivered.

** Articolo composto da pattern grafici diversi che non prevedono agganci tra loro e miscelati in modo casuale. Non si garantisce pertanto la presenza costante di tutti i soggetti.
This item is produced with different graphic patterns, randomly packed and delivered.

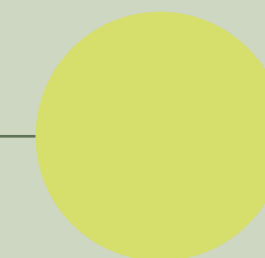

Projects

Marble	Supreme Memories Supreme Treasure Supreme Evo Supreme Classic Navona
Stone	Double Rockin' Blue Savoy Re_Tour Nordik Stone
Wood	Four Seasons Nordik Wood Cozy Flaviker-Dakota Zen
Metal	Rebel
Concrete	Hyper Backstage

Decor & Wall

Art Walls
Flow
Chrome

Outdoor

X20 - 20 mm	Supreme Memories Double Rockin' Hyper Blue Savoy Still No_w Rebel Nordik Stone Re_Tour Navona Four Seasons Nordik Wood Cozy Flaviker-Dakota
X30 - 30 mm	Backstage Nordik Stone Rebel Navona Flaviker-Dakota

Technical Information

Shadow



120x280
6 mm NAT. RETT. **0010089 *** M. 152,90



60x120
6 mm NAT. RETT. **0012582 **** M. 91,90

* Articolo composto da 2 pattern grafici diversi che non prevedono agganci tra loro e miscelati in modo casuale. Non si garantisce pertanto la presenza costante di tutti i soggetti.
This item is produced with 2 different graphic patterns, randomly packed and delivered.

** Articolo composto da pattern grafici diversi che non prevedono agganci tra loro e miscelati in modo casuale. Non si garantisce pertanto la presenza costante di tutti i soggetti.
This item is produced with different graphic patterns, randomly packed and delivered.

Landscape



120x280
6 mm NAT. RETT. **0010088 *** M. 152,90

* Articolo composto da 2 pattern grafici diversi che non prevedono agganci tra loro e miscelati in modo casuale. Non si garantisce pertanto la presenza costante di tutti i soggetti.
This item is produced with 2 different graphic patterns, randomly packed and delivered.

GRES PORCELLANATO
PORCELAIN TILES
CLASSIFICAZIONE SECONDO NORME EN 14411 (ISO 13006) ALLEGATO G GRUPPO B1a GL
CLASSIFICATION IN ACCORDANCE WITH EN 14411 (ISO 13006) ANNEX G GROUP B1a GL

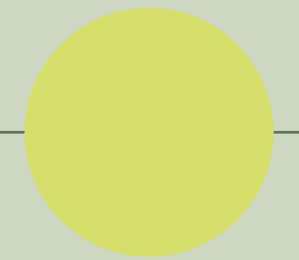

Projects

Marble	Supreme Memories Supreme Treasure Supreme Evo Supreme Classic Navona
Stone	Double Rockin' Blue Savoy Re_Tour Nordik Stone
Wood	Four Seasons Nordik Wood Cozy Flaviker-Dakota Zen
Metal	Rebel
Concrete	Hyper Backstage

Decor & Wall

Art Walls
Flow
Chrome

Outdoor

X20 - 20 mm	Supreme Memories Double Rockin' Hyper Blue Savoy Still No_w Rebel Nordik Stone Re_Tour Navona Four Seasons Nordik Wood Cozy Flaviker-Dakota
X30 - 30 mm	Backstage Nordik Stone Rebel Navona Flaviker-Dakota

Technical Information



+
Flow
Ocean
6x25

+
Flow
Saffron
6x25

+
Flow
Powder
6x25

+
Hyper
Grey
120x120

+ Flow

Pasta bianca da rivestimento
White body wall tiles



Complete Collection

Formati

Sizes

8,5 mm

6x25

satin/glossy



White

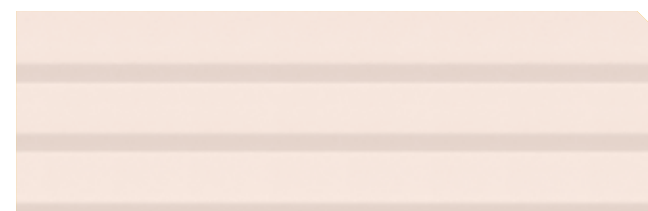

Powder

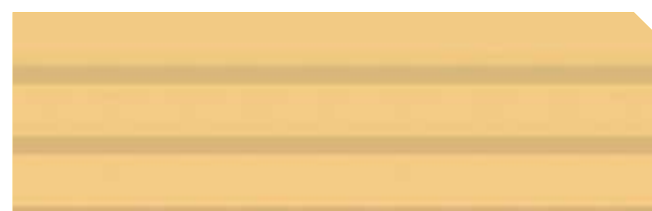

Saffron

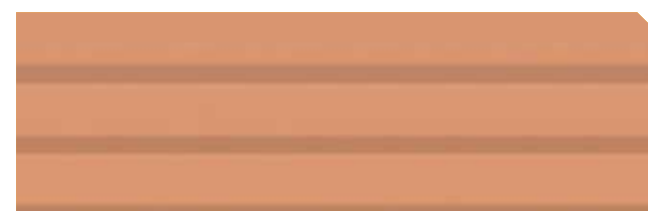

Tangerine

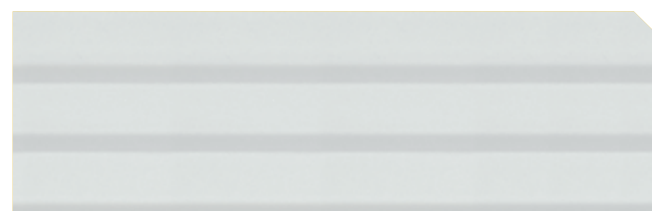

Watery



Mint

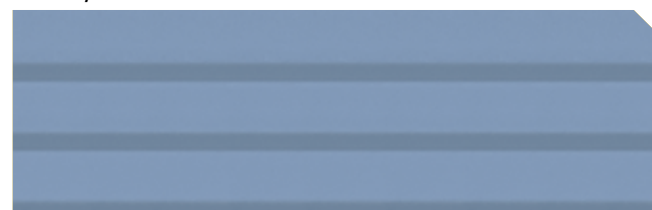

Ocean

Index



Projects

Marble	Supreme Memories Supreme Treasure Supreme Evo Supreme Classic Navona
Stone	Double Rockin' Blue Savoy Re_Tour Nordik Stone
Wood	Four Seasons Nordik Wood Cozy Flaviker-Dakota Zen
Metal	Rebel
Concrete	Hyper Backstage

Decor & Wall

Art Walls	
Flow	
Chrome	

Outdoor

X20 - 20 mm	Supreme Memories Double Rockin' Hyper Blue Savoy Still No_w Rebel Nordik Stone Re_Tour Navona Four Seasons Nordik Wood Cozy Flaviker-Dakota
X30 - 30 mm	Backstage Nordik Stone Rebel Navona Flaviker-Dakota

Technical Information



+ Flow Powder 6x25

+ Flow Watery 6x25

+ Four Seasons Biscuit 26x200

+ Art Walls Glass Lux Rett. 120x280

+ Four Seasons Biscuit 20x120

+ Flow

Decor & Wall

8,5 mm



6x25
0011933
WHITE SATIN
M 76,50



6x25
0011940
WHITE GLOSSY
M 76,50



6x25
0011934
POWDER SATIN
M 76,50



6x25
0011941
POWDER GLOSSY
M 76,50



6x25
0011937
SAFFRON SATIN
M 76,50



6x25
0011944
SAFFRON GLOSSY
M 76,50



6x25
0011938
TANGERINE SATIN
M 76,50



6x25
0011945
TANGERINE GLOSSY
M 76,50



6x25
0011935
WATERY SATIN
M 76,50



6x25
0011942
WATERY GLOSSY
M 76,50



6x25
0011936
MINT SATIN
M 76,50



6x25
0011943
MINT GLOSSY
M 76,50

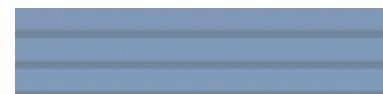

6x25
0011939
OCEAN SATIN
M 76,50

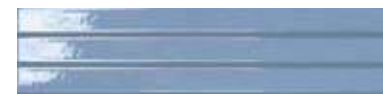

6x25
0011946
OCEAN GLOSSY
M 76,50

La struttura 3D FLOW è asimmetrica e consente di ottenere diversi effetti in parete a seconda del verso di posa. Si raccomanda pertanto di fare attenzione durante l'installazione del prodotto.
FLOW has an asymmetrical 3D structure that creates different effects depending on its orientation. Please pay attention to this when installing the product.

PASTA BIANCA DA RIVESTIMENTO
WHITE BODY WALL TILES

CLASSIFICAZIONE SECONDO NORME EN 14411 (ISO 13006) ALLEGATO L GRUPPO BIII
WHITE BODY WALL TILES - CLASSIFICATION IN ACCORDANCE WITH EN 14411 (ISO 13006) ANNEX L GROUP BIII

Index

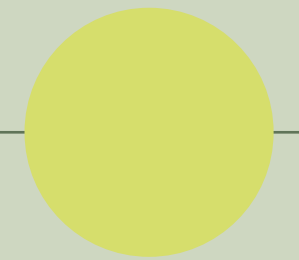

Projects

Marble	Supreme Memories Supreme Treasure Supreme Evo Supreme Classic Navona
Stone	Double Rockin' Blue Savoy Re_Tour Nordik Stone
Wood	Four Seasons Nordik Wood Cozy Flaviker-Dakota Zen
Metal	Rebel
Concrete	Hyper Backstage

Decor & Wall

Art Walls	
Flow	
Chrome	

Outdoor

X20 - 20 mm	Supreme Memories Double Rockin' Hyper Blue Savoy Still No_w Rebel Nordik Stone Re_Tour Navona Four Seasons Nordik Wood Cozy Flaviker-Dakota
X30 - 30 mm	Backstage Nordik Stone Rebel Navona Flaviker-Dakota

Technical Information



+
Chrome
White Soft
120x280

+
Blue Savoy
Blue
120x280

+
Blue Savoy
Blue
120x280

+
Nordik Wood
Gold
20x120

+ Chrome

Gres porcellanato tutta massa
Full body porcelain

Formati

Sizes

6 mm	
160x320	nat/lux
120x280	soft/lux
8,5 mm	
120x120	nat/lux
60x120	nat/lux

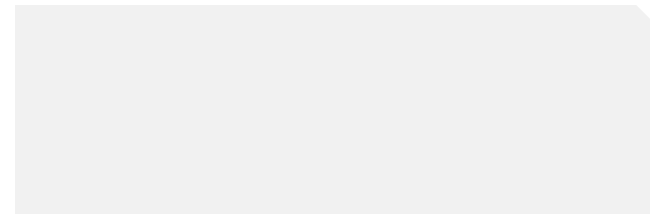

White



Black

Index

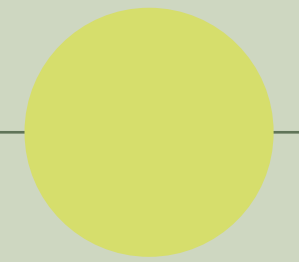

Projects

Marble	Supreme Memories Supreme Treasure Supreme Evo Supreme Classic Navona
Stone	Double Rockin' Blue Savoy Re_Tour Nordik Stone
Wood	Four Seasons Nordik Wood Cozy Flaviker-Dakota Zen
Metal	Rebel
Concrete	Hyper Backstage

Decor & Wall

Art Walls	Flow Chrome
-----------	----------------

Outdoor

X20 - 20 mm	Supreme Memories Double Rockin' Hyper Blue Savoy Still No_w Rebel Nordik Stone Re_Tour Navona Four Seasons Nordik Wood Cozy Flaviker-Dakota
X30 - 30 mm	Backstage Nordik Stone Rebel Navona Flaviker-Dakota

Technical Information

White

6 mm			
160x320	LUX R.	0005376	M. 166,50
	NAT. R.	0005374	M. 146,90
120x280 *	SOFT R.	0008044	M. 116,90
	LUX R.	0008639	M. 134,90
8,5 mm			
120x120	LUX R.	0013304	M. 117,50
	NAT. R.	0013302	M. 89,50
60x120	LUX R.	0013303	M. 91,90
	NAT. R.	0013301	M. 69,50



Black

6 mm			
160x320	NAT. R.	0005373	M. 146,90
	SOFT R.	0008638	M. 116,90
8,5 mm			
120x120	NAT. R.	0013808	M. 89,50
	NAT. R.	0013809	M. 69,50

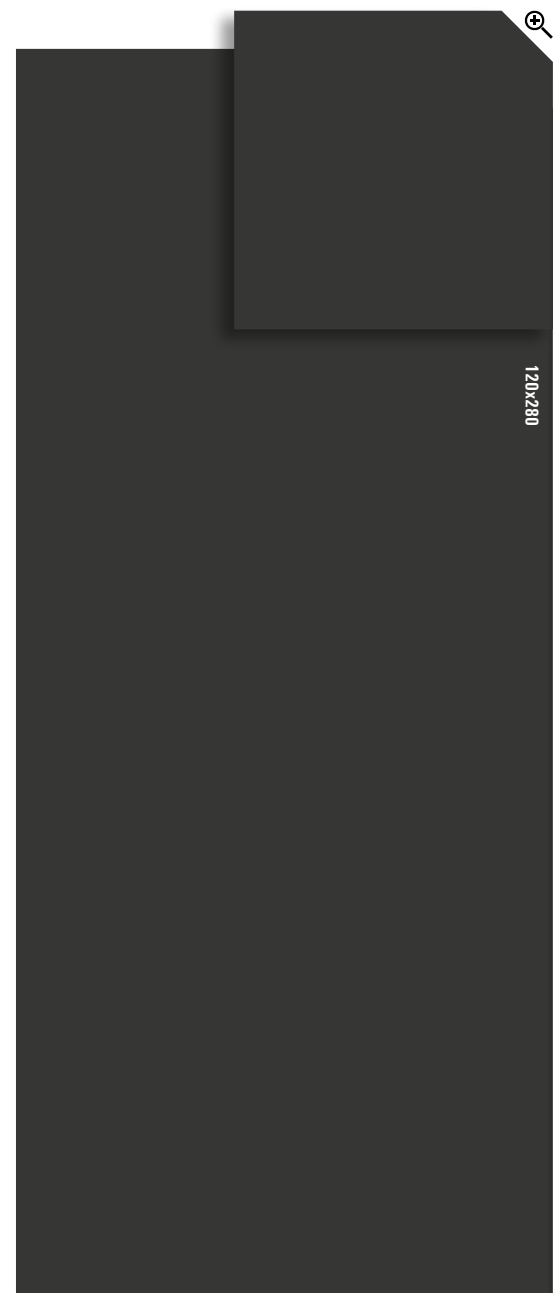

Decor
e Pezzi Speciali
Decors
and Special Trims



	White	Black	
 8,5 mm Battiscopa 5,5x120	NAT RETT. 0012513	0013810	P. 11,50
	LUX RETT. 0012513	-	P. 15,50

GRES PORCELLANATO TUTTA MASSA
FULL BODY PORCELAIN

SUPERFICIE NAT./SOFT CLASSIFICAZIONE SECONDO NORME EN 14411 (ISO 13006) ALLEGATO G GRUPPO BIa UGL
NAT./SOFT SURFACE CLASSIFICATION IN ACCORDANCE WITH EN 14411 (ISO 13006) ANNEX G GROUP BIa UGL



PROPRIETÀ FISICO-CHIMICHE PHYSICAL-CHEMICAL PROPERTIES	NORMA NORM	VALORE PRESCRITTO DALLE NORME VALUE PRESCRIBED FROM THE NORMS	*VAL. / VALUE FLAVIKER NAT.
RESISTENZA ALLO SCIVOLAMENTO SLIP RESISTANCE	B.C.R.A. C.A.	μ 0,19 SCIVOLISTÀ PERICOLOSA - DANGEROUSLY SLIPPERY $0,20 < \mu < 0,39$ SCIVOLISTÀ ECCESSIVA - EXCESSIVELY SLIPPERY $0,40 < \mu < 0,74$ ATTRITO SODDISFACENTE - SATISFACTORY GRIP μ 0,75 ATTRITO ECCELLENTE - EXCELLENT GRIP	> 0,40 > 0,40
	ASTM C 1028 (S.C.O.F.)	SLIP RESISTANT (> 0,60)	> 0,60 DRY > 0,60 WET
	DIN 51130	IN FUNZIONE DELL'AMBIENTE O DELLA ZONA DI LAVORO BASING ON THE ENVIRONMENT OR THE WORKING AREA	R9
	DIN 51097	-	A
	ANSI A 137-1:2012 (D.C.O.F.)	> 0,42	> 0,42

*Valori medi di produzione / Average production values

Index

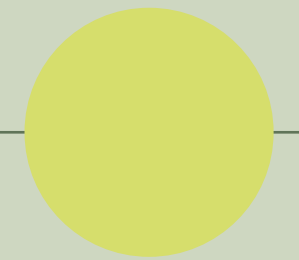

Projects

Marble	Supreme Memories
	Supreme Treasure
	Supreme Evo
	Supreme Classic Navona
Stone	Double Rockin'
	Blue Savoy
	Re_Tour
	Nordik Stone
Wood	Four Seasons
	Nordik Wood
	Cozy
	Flaviker-Dakota
	Zen
Metal	Rebel
Concrete	Hyper Backstage

Decor & Wall

Art Walls
Flow
Chrome

Outdoor

X20 - 20 mm	Supreme Memories
	Double
	Rockin'
	Hyper
	Blue Savoy
	Still No_w
	Rebel
	Nordik Stone
	Re_Tour
	Navona
	Four Seasons
X30 - 30 mm	Nordik Wood
	Cozy
	Flaviker-Dakota
	Backstage
	Nordik Stone
	Rebel
	Navona
	Flaviker-Dakota

Technical Information

Outdoor

X20 - 20 mm X30 - 30 mm

Supreme Memories	232	Backstage	250
Double	233	Nordik Stone	250
Rockin'	234	Rebel	251
Hyper	235	Navona	251
Blue Savoy	236	Flaviker-Dakota	251
Still No_w	237		
Rebel	238		
Nordik Stone	239		
Re_tour	240		
Navona	241		
Four Seasons	242		
Nordik Wood	243		
Cozy	244		
Flaviker-Dakota	245		

+ X20

GRES PORCELLANATO A MASSA COLORATA
FULL BODY COLORED PORCELAIN



Index



Projects

Marble	Supreme Memories Supreme Treasure Supreme Evo Supreme Classic Navona
Stone	Double Rockin' Blue Savoy Re_Tour Nordik Stone
Wood	Four Seasons Nordik Wood Cozy Flaviker-Dakota Zen
Metal	Rebel
Concrete	Hyper Backstage

Decor & Wall

	Art Walls Flow Chrome
--	-----------------------------

Outdoor

X20 - 20 mm	Supreme Memories Double Rockin' Hyper Blue Savoy Still No_w Rebel Nordik Stone Re_Tour Navona Four Seasons Nordik Wood Cozy Flaviker-Dakota
X30 - 30 mm	Backstage Nordik Stone Rebel Navona Flaviker-Dakota

Technical Information

+ X20 Supreme Memories

Graphic variations

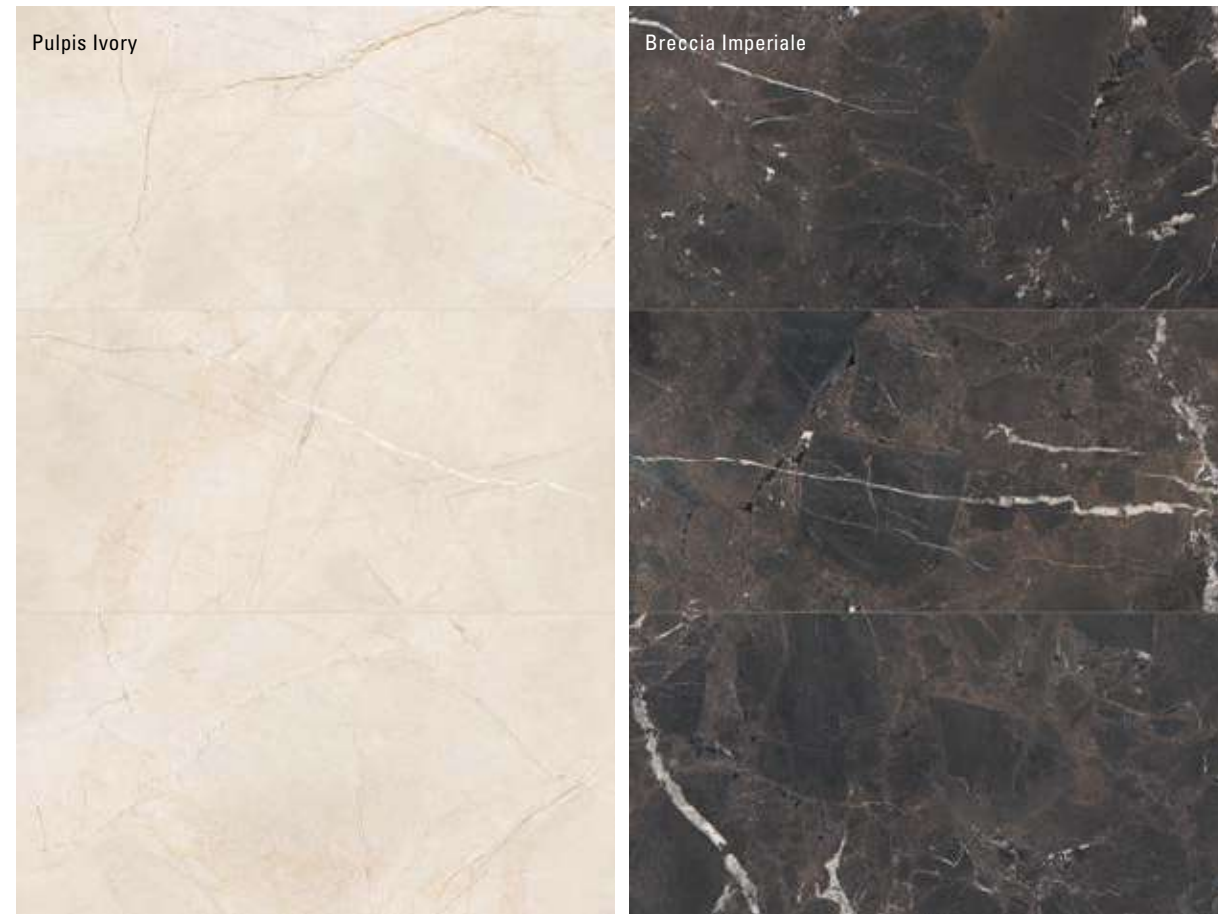

R11

COLOURS



60x120
0011821
SUPREME MEMORIES
PULPIS IVORY
20 MM R11 RETT. P.TECH
M. 87,90

60x120
0012571
SUPREME MEMORIES
BRECCIA IMPERIALE
20 MM R11 RETT. P.TECH
M. 87,90

+ X20 Double

Outdoor X20

Graphic variations



R11

COLOURS



60x120
0014304
DOUBLE PLAIN BEIGE
20 MM R11 RETT. P. TECH
M. 87,90

60x60
0016218
DOUBLE PLAIN BEIGE
20 MM R11 RETT. P. TECH
M. 73,50

60x120
0014302
DOUBLE LINEAR BEIGE
20 MM R11 RETT. P. TECH
M. 87,90

60x120
0014303
DOUBLE PLAIN GREY
20 MM R11 RETT. P. TECH
M. 87,90

60x60
0016217
DOUBLE PLAIN GREY
20 MM R11 RETT. P. TECH
M. 73,50

60x120
0014301
DOUBLE LINEAR GREY
20 MM R11 RETT. P. TECH
M. 87,90

Index

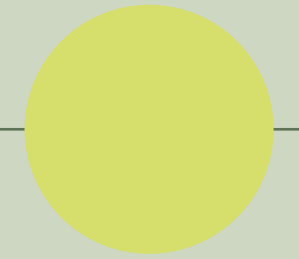

Projects

Marble	Supreme Memories Supreme Treasure Supreme Evo Supreme Classic Navona
Stone	Double Rockin' Blue Savoy Re_Tour Nordik Stone
Wood	Four Seasons Nordik Wood Cozy Flaviker-Dakota Zen
Metal	Rebel
Concrete	Hyper Backstage

Decor & Wall

Art Walls Flow Chrome

Outdoor

X20 - 20 mm	Supreme Memories Double Rockin' Hyper Blue Savoy Still No_w Rebel Nordik Stone Re_Tour Navona Four Seasons Nordik Wood Cozy Flaviker-Dakota
X30 - 30 mm	Backstage Nordik Stone Rebel Navona Flaviker-Dakota

Technical Information

Graphic variations



R11

COLOURS

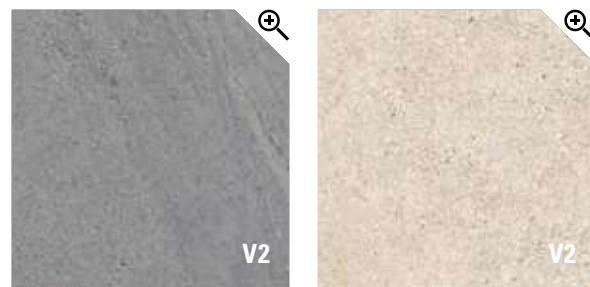

60x120
0010146
ROCKIN' GREY
20 MM R11 RETT. P. TECH
M.87,90

60x120
0010145
ROCKIN' DESERT
20 MM R11 RETT. P. TECH
M.87,90

120x120
0012901
ROCKIN' DESERT
20 MM R11 RETT. P. TECH
M.108,50

Graphic variations



R11

COLOURS



60x120
0002770
HYPER SILVER
20 MM R11 RETT. P. TECH
M.87,90

60x120
0002771
HYPER GREY
20 MM R11 RETT. P. TECH
M.87,90

60x120
0002772
HYPER TAUPE
20 MM R11 RETT. P. TECH
M.87,90

120x120
0008415
HYPER WHITE
20 MM R11 RETT. P. TECH
M.108,50

Index

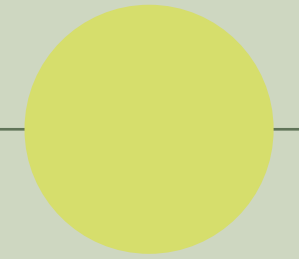

Projects

Marble	Supreme Memories Supreme Treasure Supreme Evo Supreme Classic Navona
Stone	Double Rockin' Blue Savoy Re_Tour Nordik Stone
Wood	Four Seasons Nordik Wood Cozy Flaviker-Dakota Zen
Metal	Rebel
Concrete	Hyper Backstage

Decor & Wall

Art Walls Flow Chrome

Outdoor

X20 - 20 mm	Supreme Memories Double Rockin' Hyper Blue Savoy Still No_w Rebel Nordik Stone Re_Tour Navona Four Seasons Nordik Wood Cozy Flaviker-Dakota
X30 - 30 mm	Backstage Nordik Stone Rebel Navona Flaviker-Dakota

Technical Information

Graphic variations



R11

COLOURS



60x120
0006338
BLUE SAVOY GREY
20 MM R11 RETT. P.TECH
M.87,90

120x120
0012899
BLUE SAVOY GREY
20 MM R11 RETT. P.TECH
M.108,50

60x120
0008358
BLUE SAVOY MOON
20 MM R11 RETT. P.TECH
M.87,90

120x120
0012900
BLUE SAVOY MOON
20 MM R11 RETT. P.TECH
M.108,50

60x120
0006339
BLUE SAVOY GRAPHITE
20 MM R11 RETT. P.TECH
M.87,90

Graphic variations



R11

COLOURS



60x120
0000948
STILL NO_W SAND
20 MM R11 RETT. P.TECH
M.87,90

60x120
0000949
STILL NO_W GRAY
20 MM R11 RETT. P.TECH
M.87,90

60x120
0000950
STILL NO_W COAL
20 MM R11 RETT. P.TECH
M.87,90

Index

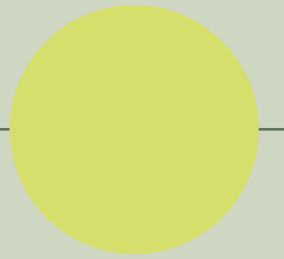

Projects

Marble	Supreme Memories Supreme Treasure Supreme Evo Supreme Classic Navona
Stone	Double Rockin' Blue Savoy Re_Tour Nordik Stone
Wood	Four Seasons Nordik Wood Cozy Flaviker-Dakota Zen
Metal	Rebel
Concrete	Hyper Backstage

Decor & Wall

	Art Walls Flow Chrome
--	-----------------------------

Outdoor

X20 - 20 mm	Supreme Memories Double Rockin' Hyper Blue Savoy Still No_w Rebel Nordik Stone Re_Tour Navona Four Seasons Nordik Wood Cozy Flaviker-Dakota
X30 - 30 mm	Backstage Nordik Stone Rebel Navona Flaviker-Dakota

Technical Information

Graphic variations



R11

COLOURS

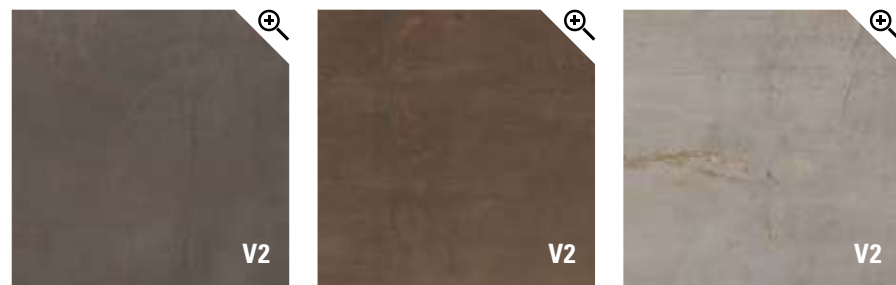

90x90
0004252
REBEL LEAD
20 MM R11 RETT. P. TECH
M.91,50

90x90
0004251
REBEL BRONZE
20 MM R11 RETT. P. TECH
M.91,50

90x90
0004253
REBEL SILVER
20 MM R11 RETT. P. TECH
M.91,50

Graphic variations



R11

COLOURS

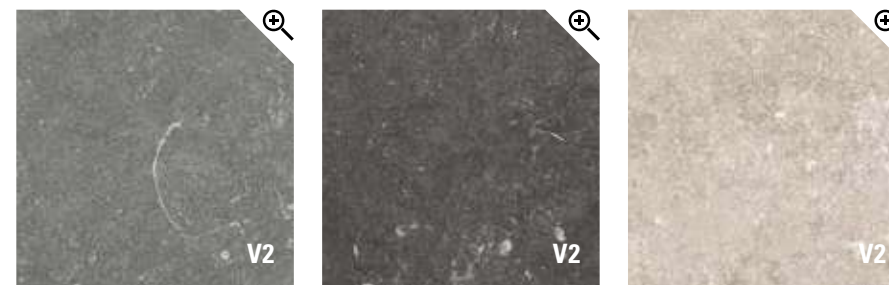

60x120
0012250
NORDIK STONE GREY
20 MM R11 RETT. P. TECH
M.87,90

90x90
0004236
NORDIK STONE GREY
20 MM R11 RETT. P. TECH
M.91,50

90x90
0004237
NORDIK STONE BLACK
20 MM R11 RETT. P. TECH
M.91,50

60x120
0012249
NORDIK STONE SAND
20 MM R11 RETT. P. TECH
M.87,90

Index

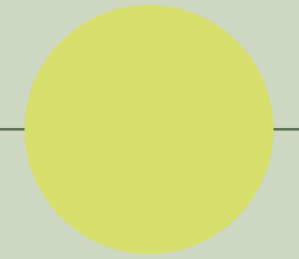

Projects

Marble	Supreme Memories Supreme Treasure Supreme Evo Supreme Classic Navona
Stone	Double Rockin' Blue Savoy Re_Tour Nordik Stone
Wood	Four Seasons Nordik Wood Cozy Flaviker-Dakota Zen
Metal	Rebel
Concrete	Hyper Backstage

Decor & Wall

	Art Walls Flow Chrome
--	-----------------------------

Outdoor

X20 - 20 mm	Supreme Memories Double Rockin' Hyper Blue Savoy Still No_w Rebel Nordik Stone Re_Tour Navona Four Seasons Nordik Wood Cozy Flaviker-Dakota
X30 - 30 mm	Backstage Nordik Stone Rebel Navona Flaviker-Dakota

Technical Information

Graphic variations



R11

COLOURS



60x90
0007178
RE_TOUR FOG
20 MM R11 RETT. P. TECH
M.83,50

60x90
0007177
RE_TOUR ROPE
20 MM R11 RETT. P. TECH
M.83,50

Graphic variations



R11

COLOURS



60x120
0011595
NAVONA HONEY VEIN
20 MM R11 RETT. P. TECH
M.87,90

60x90
0007180
NAVONA HONEY VEIN
20 MM R11 RETT. P. TECH
M.83,50

60x60
0012104
NAVONA HONEY VEIN
20 MM R11 RETT. P. TECH
M.73,50

60x90
0007181
NAVONA HONEY CROSS
20 MM R11 RETT. P. TECH
M.83,50

60x60
0012103
NAVONA HONEY CROSS
20 MM R11 RETT. P. TECH
M.73,50

60x120
0011594
NAVONA BONE VEIN
20 MM R11 RETT. P. TECH
M.87,90

Index

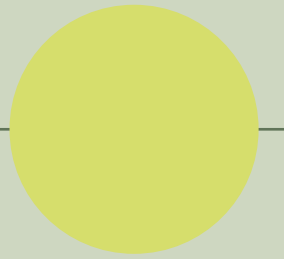

Projects

Marble	Supreme Memories Supreme Treasure Supreme Evo Supreme Classic Navona
Stone	Double Rockin' Blue Savoy Re_Tour Nordik Stone
Wood	Four Seasons Nordik Wood Cozy Flaviker-Dakota Zen
Metal	Rebel
Concrete	Hyper Backstage

Decor & Wall

	Art Walls Flow Chrome
--	-----------------------------

Outdoor

X20 - 20 mm	Supreme Memories Double Rockin' Hyper Blue Savoy Still No_w Rebel Nordik Stone Re_Tour Navona Four Seasons Nordik Wood Cozy Flaviker-Dakota
X30 - 30 mm	Backstage Nordik Stone Rebel Navona Flaviker-Dakota

Technical Information

Graphic variations



R11

COLOURS

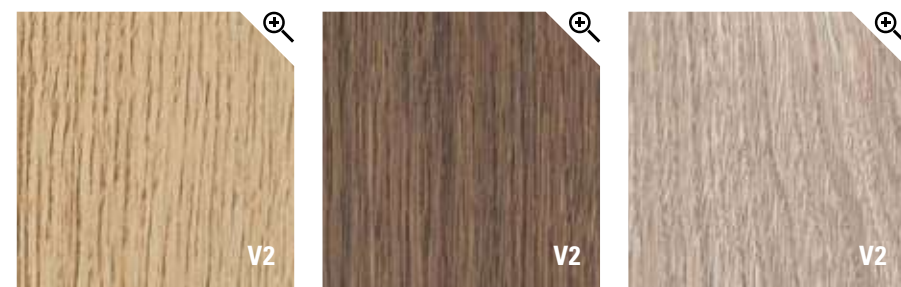

30x180
0012202
FOUR SEASONS HONEY
20 MM R11 RETT. P. TECH
M.100,50

30x180
0012201
FOUR SEASONS CHOCOLATE
20 MM R11 RETT. P. TECH
M.100,50

30x180
0012203
FOUR SEASONS BISCUIT
20 MM R11 RETT. P. TECH
M.100,50

30x120
0011819
FOUR SEASONS HONEY
20 MM R11 RETT. P. TECH
M.87,90

30x120
0011818
FOUR SEASONS CHOCOLATE
20 MM R11 RETT. P. TECH
M.87,90

30x120
0011820
FOUR SEASONS BISCUIT
20 MM R11 RETT. P. TECH
M.87,90

Graphic variations



R11

COLOURS



30x180
0006454
NORDIK WOOD GOLD
20 MM R11 RETT. P. TECH
M.100,50

30x180
0008906
NORDIK WOOD BEIGE
20 MM R11 RETT. P. TECH
M.100,50

30x180
0006455
NORDIK WOOD BROWN
20 MM R11 RETT. P. TECH
M.100,50

30x120
0004816
NORDIK WOOD GOLD
20 MM R11 RETT. P. TECH
M.87,90

30x120
0004815
NORDIK WOOD BEIGE
20 MM R11 RETT. P. TECH
M.87,90



Projects

Marble	Supreme Memories Supreme Treasure Supreme Evo Supreme Classic Navona
Stone	Double Rockin' Blue Savoy Re_Tour Nordik Stone
Wood	Four Seasons Nordik Wood Cozy Flaviker-Dakota Zen
Metal	Rebel
Concrete	Hyper Backstage

Decor & Wall

	Art Walls Flow Chrome
--	-----------------------------

Outdoor

X20 - 20 mm	Supreme Memories Double Rockin' Hyper Blue Savoy Still No_w Rebel Nordik Stone Re_Tour Navona Four Seasons Nordik Wood Cozy Flaviker-Dakota
X30 - 30 mm	Backstage Nordik Stone Rebel Navona Flaviker-Dakota

Technical Information

Graphic variations



R11

COLOURS



30x120
0003084
COZY HAVANA
20 MM R11 RETT. P. TECH
M.87,90

30x120
0003085
COZY BARK
20 MM R11 RETT. P. TECH
M.87,90

30x180
0006567
COZY BROWN
20 MM R11 RETT. P. TECH
M.100,50

Graphic variations



R11

COLOURS



30x120
DK 3113 M
FLAVIKER-DAKOTA NATURALE
20 MM R11 RETT. P. TECH
M.87,90

30x120
DK 3130 M
FLAVIKER-DAKOTA AVANA
20 MM R11 RETT. P. TECH
M.87,90

30x180
0008915
FLAVIKER-DAKOTA NATURALE
20 MM R11 RETT. P. TECH
M.100,50

Index

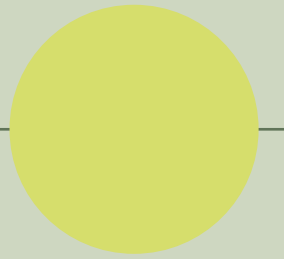

Projects

Marble	Supreme Memories Supreme Treasure Supreme Evo Supreme Classic Navona
Stone	Double Rockin' Blue Savoy Re_Tour Nordik Stone
Wood	Four Seasons Nordik Wood Cozy Flaviker-Dakota Zen
Metal	Rebel
Concrete	Hyper Backstage

Decor & Wall

	Art Walls Flow Chrome
--	-----------------------------

Outdoor

X20 - 20 mm	Supreme Memories Double Rockin' Hyper Blue Savoy Still No_w Rebel Nordik Stone Re_Tour Navona Four Seasons Nordik Wood Cozy Flaviker-Dakota
X30 - 30 mm	Backstage Nordik Stone Rebel Navona Flaviker-Dakota

Technical Information

Pezzi Speciali Special Trims

R11 P. tech	Bullnose	Elemento L	Elemento L Grip	Griglia	Ang. Griglia SX	Ang. Griglia DX
	90x90 1 P. 205,50	15x90x5 2 P. 136,90	15x90x5 2 P. 159,90	18x90 4 P. 228,90	18x90 4 P. 297,50	18x90 4 P. 297,50
REBEL BRONZE	0007850	0004255	0007096	0004258	0004261	0004264
REBEL LEAD	0007851	0004256	0007097	0004259	0004262	0004265
REBEL SILVER	0007852	0004257	0007098	0004260	0004263	0004266
NORDIK STONE GREY	0007848	0004239	0007094	0004242	0004245	0004248
NORDIK STONE BLACK	0007849	0004240	0007095	0004243	0004246	0004249
NORDIK WOOD GOLD 30x180	-	0006558	0007107	0006560	0006562	0006564
NORDIK WOOD BEIGE 30x180	-	0008907	0008908	0008909	0008910	0008911
NORDIK WOOD BROWN 30x180	-	0006559	0007108	0006561	0006563	0006565
COZY HAVANA 30x180	-	0006568	0007105	0006570	0006572	0006574
COZY BROWN 30x180	-	0006569	0007106	0006571	0006573	0006575
FLAVIKER-DAKOTA NATURALE 30x180	-	0008916	0008917	0008918	0008919	0008920
	60x120 1 P. 194,50	15x60x5 2 P. 102,50	15x60x5 2 P. 113,90	15x60 4 P. 194,50	15x60 4 P. 262,90	15x60 4 P. 262,90
SUP. MEMORIES PULPIS IVORY	0012902	0012572	0012574	0012576	0012578	0012580
SUP. MEMORIES BRECCIA IMPERIALE	0012903	0012573	0012575	0012577	0012579	0012581
NAVONA BONE VEIN	0012388	0012389	0012390	0012391	0012392	0012393
DOUBLE PLAIN BEIGE	0015103	0015107	0015111	0015119	0015121	0015123
DOUBLE LINEAR BEIGE	0015101	0015105	0015109	0015113	0015115	0015117
DOUBLE PLAIN GREY	0015102	0015106	0015110	0015118	0015120	0015122
DOUBLE LINEAR GREY	0015100	0015104	0015108	0015112	0015114	0015116
ROCKIN' DESERT	0010459	0010461	0010463	0010465	0010467	0010469
ROCKIN' GREY	0010460	0010462	0010464	0010466	0010468	0010470
HYPER SILVER	0007840	0002773	0007089	0002776	0002779	0002782
HYPER GREY	0007841	0002774	0007090	0002777	0002780	0002783
HYPER TAUPE	0007842	0002775	0007091	0002778	0002781	0002784
BLUE SAVOY MOON	0008359	0008360	0008361	0008362	0008363	0008364
BLUE SAVOY GREY	0007843	0006340	0007103	0006342	0006344	0006346
BLUE SAVOY GRAPHITE	0007844	0006341	0007779	0006343	0006345	0006347
STILL_NO_W SAND	0007837	0001015	0007082	0001006	0001009	0001012
STILL_NO_W GRAY	0007838	0001016	0007083	0001007	0001010	0001013
STILL_NO_W COAL	0007839	0001017	0007084	0001008	0001011	0001014
	60x90 1 P. 170,90	15x60x5 2 P. 102,50	15x60x5 2 P. 113,90	15x60 4 P. 194,50	15x60 4 P. 262,90	15x60 4 P. 262,90
NAVONA HONEY VEIN	0007859	0006350	0007104	0006351	0006352	0006353
NAVONA HONEY CROSS	0007860	0007184	0007185	0007186	0007187	0007188
RE_TOUR ROPE	0007857	0006030	0007101	0006032	0006034	0006036
RE_TOUR FOG	0007858	0006031	0007102	0006033	0006035	0006037
	30x120 1 P. 148,50	15x60x5 2 P. 102,50	15x60x5 2 P. 113,90	15x60 4 P. 194,50	15x60 4 P. 262,90	15x60 4 P. 262,90
FOUR SEASONS CHOCOLATE	0012553	0012204	0012207	0012210	0012213	0012216
FOUR SEASONS HONEY	0012554	0012205	0012208	0012211	0012214	0012217
FOUR SEASONS BISCUIT	0012555	0012206	0012209	0012212	0012215	0012218
NORDIK WOOD BEIGE 30x120	0007868	0004817	0007099	0004819	0004821	0004823
NORDIK WOOD GOLD 30x120	0007869	0004818	0007100	0004820	0004822	0004824
COZY HAVANA 30x120	0007866	0003105	0007092	0003107	0003109	0003111
COZY BARK 30x120	0007867	0003106	0007093	0003108	0003110	0003112
FLAVIKER-DAKOTA NATURALE 30x120	0007870	DK EL 13 M	0007113	DK GR 13 M	DK GS 13 M	DK GD 13 M
FLAVIKER-DAKOTA AVANA 30x120	0007871	DK EL 30 M	0007114	DK GR 30 M	DK GS 30 M	DK GD 30 M

Informazioni tecniche Technical details

Posa tradizionale
Traditional installation



La posa tradizionale è ideale per la realizzazione di pavimentazioni carrabili. Traditional installation is ideal for floorings that will be driven over by vehicles.

Posa a secco su sabbia
Dry installation on sand



La posa su sabbia permette di creare percorsi e camminamenti per spiagge e stabilimenti balneari. Installing on top of sand is ideal for creating paths and walkways on beaches and beach bars.

Posa a secco su ghiaia
Dry installation on gravel



La posa su ghiaia permette il perfetto drenaggio delle acque piovane. Installing on gravel enables perfect drainage of rainwater.

Posa sopraelevata da esterno
Outdoor raised laying system



Il sistema di pavimentazione sopraelevata prevede l'utilizzo di supporti portanti di tipo autolivellante, regolabili oppure fissi che si adattano con semplicità e sicurezza ad ogni tipo di pavimento sottostante. Il sistema permette la realizzazione di piani di posa con altezze variabili, da terra, comprese fra 25 e 270 mm. L'indipendenza della pavimentazione dai supporti garantisce l'assorbimento di eventuali movimenti strutturali. Il sistema sopraelevato non necessita di massetto in cemento e consente una diminuzione del peso sulla struttura portante. Le fughe aperte tra una piastrella ed un'altra consentono un facile deflusso dell'acqua piovana evitando tutti i rischi di accumulo o di ristagno. La presenza dell'intercapedine fra il piano di calpestio e il piano di appoggio favorisce l'aerazione e l'isolamento termico. Questa soluzione permette inoltre il passaggio di impianti e tubazioni nell'intercapedine, e la facile ispezione degli stessi una volta installata la pavimentazione.

Posa a secco su erba
Dry installation on grass



La posa diretta su erba permette di creare percorsi e camminamenti integrandosi perfettamente nell'ambiente. Installing directly on top of grass enables the creation of paths and walkways that blend in perfectly with the surroundings.

Per informazioni sull'utilizzo dei supporti per pavimentazione sopraelevata, consultare il catalogo X20. To see more about the use of self-levelling for raised floor consult the X20 catalog.

Index

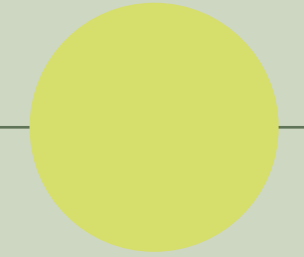

Projects

Marble	Supreme Memories Supreme Treasure Supreme Evo Supreme Classic Navona
Stone	Double Rockin' Blue Savoy Re_Tour Nordik Stone
Wood	Four Seasons Nordik Wood Cozy Flaviker-Dakota Zen
Metal	Rebel
Concrete	Hyper Backstage

Decor & Wall

	Art Walls Flow Chrome
--	-----------------------------

Outdoor

X20 - 20 mm	Supreme Memories Double Rockin' Hyper Blue Savoy Still No_w Rebel Nordik Stone Re_Tour Navona Four Seasons Nordik Wood Cozy Flaviker-Dakota
X30 - 30 mm	Backstage Nordik Stone Rebel Navona Flaviker-Dakota

Technical Information

SOLUZIONI PER SUPERFICI CARRABILI URBANE E RESIDENZIALI
DRIVE-OVER SURFACES SOLUTIONS FOR URBAN AND RESIDENTIAL SPACES

I prodotti X30, grazie allo spessore maggiorato di 30 mm, hanno le caratteristiche tecniche necessarie per la posa di tutte le situazioni carrabili in esterno, dagli spazi residenziali privati fino ai centri urbani. In caso di traffico leggero, come nei viali, nei cortili e nei parcheggi delle abitazioni, la pavimentazione può essere installata senza incollaggio. In questo caso il materiale si stende su una base di aggregati lapidei di varia granulometria compattati, avendo cura di utilizzare i comuni distanziatori in materiale plastico. Nelle zone sottoposte a traffico elevato, come percorsi stradali e piazze cittadine, è invece necessario effettuare la posa su massetto cementizio con malta d'allettamento, seguendo procedimenti analoghi a quelli utilizzati per la posa dei materiali naturali.

With their extra-large 30 mm thickness, X30 slabs have the necessary technical characteristics for use in any outdoor vehicular application, from private residential areas to urban centres. For light traffic situations such as driveways, courtyards and residential parking spaces, the slabs can be installed without adhesive. In this case, they should be laid on a base of compacted stone aggregates of various sizes and positioned using ordinary plastic spacers. In heavy traffic areas such as roads and city squares, the slabs should be laid on a cement screed with bedding mortar following similar procedures to those used for the installation of natural materials.



TRAFFICO LEGGERO
LIGHT TRAFFIC



POSA A SECCO SU GHIAIA
DRY LAYING ON GRAVEL



TRAFFICO LEGGERO
LIGHT TRAFFIC



POSA A SECCO SU GHIAIA
DRY LAYING ON GRAVEL



TRAFFICO URBANO
URBAN TRAFFIC



POSA SU MASSETTO
LAYING ON CEMENT SCREED



Index

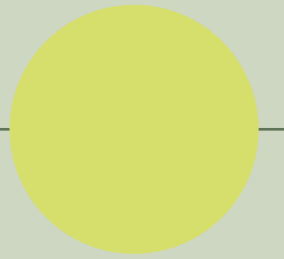

Projects

Marble	Supreme Memories Supreme Treasure Supreme Evo Supreme Classic Navona
Stone	Double Rockin' Blue Savoy Re_Tour Nordik Stone
Wood	Four Seasons Nordik Wood Cozy Flaviker-Dakota Zen
Metal	Rebel
Concrete	Hyper Backstage

Decor & Wall

	Art Walls Flow Chrome
--	-----------------------------

Outdoor

X20 - 20 mm	Supreme Memories Double Rockin' Hyper Blue Savoy Still No_w Rebel Nordik Stone Re_Tour Navona Four Seasons Nordik Wood Cozy Flaviker-Dakota
X30 - 30 mm	Backstage Nordik Stone Rebel Navona Flaviker-Dakota

Technical Information



90x90
0009235
BACKSTAGE GRAPHITE
30 MM R11 RETT.
M.142,50



90x90
0009236
BACKSTAGE ASH
30 MM R11 RETT.
M.142,50

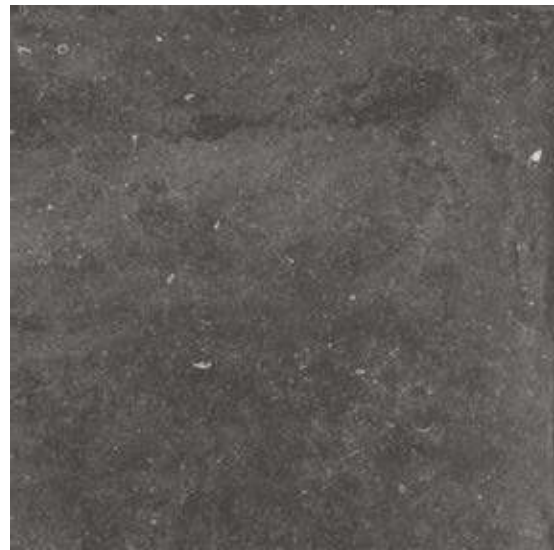

90x90
0009237
NORDIK STONE BLACK
30 MM R11 RETT.
M.142,50



60x60
0009238
REBEL SILVER
30 MM R11 RETT.
M.120,50



60x60
0009239
NAVONA HONEY CROSS
30 MM R11 RETT.
M.120,50



30x120
0009240
FLAVIKER-DAKOTA NATURALE
30 MM R11 RETT.
M.142,50

Index

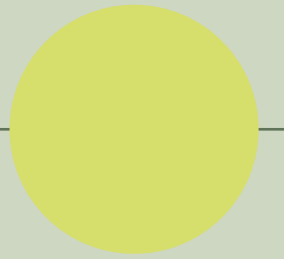

Projects

Marble	Supreme Memories Supreme Treasure Supreme Evo Supreme Classic Navona
Stone	Double Rockin' Blue Savoy Re_Tour Nordik Stone
Wood	Four Seasons Nordik Wood Cozy Flaviker-Dakota Zen
Metal	Rebel
Concrete	Hyper Backstage

Decor & Wall

	Art Walls Flow Chrome
--	-----------------------------

Outdoor

X20 - 20 mm	Supreme Memories Double Rockin' Hyper Blue Savoy Still No_w Rebel Nordik Stone Re_Tour Navona Four Seasons Nordik Wood Cozy Flaviker-Dakota
X30 - 30 mm	Backstage Nordik Stone Rebel Navona Flaviker-Dakota

Technical Information

Technical Info



Consigli di posa e pulizia

Installation and cleaning advice



Caratteristiche tecniche

Technical characteristics



Ecosostenibilità e certificazioni

Eco-sustainability and certifications

Condizioni generali di vendita

General sales terms and conditions

254

Imballi

Packaging

259

Consultation Guide

Nome articolo
Item name

Bianco Vagli

6 mm

120x280

LUX 3D R.
SOFT. R.

Spessore
Thickness

0014876

0011824

M 138,50

M 107,50

Formato
Size

Finiture
Finishes

Codice articolo
Item code

CATEGORIA PREZZO:

M= prezzo espresso in Euro da calcolarsi al mq
P= prezzo espresso in Euro da calcolarsi al pezzo

Pricing categories:
M= price in euro per square meter
P= price in euro per unit

VARIAZIONE CROMATICA

Colour shade variation |
Variation de nuances
Farbabweichung |
Variación cromática |
ИЗМЕНЕНИЕ ЦВЕТА



V1 ASPETTO UNIFORME

V1 uniform appearance | V1 aspect uniforme
V1 einheitliche Optik | V1 aspecto uniforme
V1 ОДНОРОДНЫЙ ВИД



V3 MODERATA VARIAZIONE

V3 moderate variation | V3 variation modérée
V3 mässige Farbabweichung | V3 variación moderada
V3 УМЕРЕННОЕ ИЗМЕНЕНИЕ



V2 LIEVE VARIAZIONE

V2 minimal variation | V2 légère variation
V2 leichte Farbabweichung | V2 variación ligera
V2 ЛЕГКОЕ ИЗМЕНЕНИЕ



V4 FORTE VARIAZIONE

V4 substantial variation | V4 effet dénuancé très accentué
V4 starke Farbabweichung | V4 variación evidente
V4 СИЛЬНОЕ ИЗМЕНЕНИЕ

Zoom su grafica
Zoom on graphics

Index



Projects

Marble	Supreme Memories Supreme Treasure Supreme Evo Supreme Classic Navona
Stone	Double Rockin' Blue Savoy Re_Tour Nordik Stone
Wood	Four Seasons Nordik Wood Cozy Flaviker-Dakota Zen
Metal	Rebel
Concrete	Hyper Backstage

Decor & Wall

	Art Walls Flow Chrome
--	-----------------------------

Outdoor

X20 - 20 mm	Supreme Memories Double Rockin' Hyper Blue Savoy Still No_w Rebel Nordik Stone Re_Tour Navona Four Seasons Nordik Wood Cozy Flaviker-Dakota
X30 - 30 mm	Backstage Nordik Stone Rebel Navona Flaviker-Dakota

Technical Information

Condizioni generali di vendita

- 1) APPROVAZIONE** - Gli ordini pervenutici sono per noi impegnativi solo dopo la nostra conferma scritta.
- 2) CONSEGNA** - La consegna del materiale s’intende avvenuta a carico effettuato presso i nostri magazzini. Tutti i rischi di trasporto, compresi ammanchi, rotture, deterioramenti e manomissioni sono a carico del Committente anche se il prezzo pattuito è franco di porto, FOB o C&F. Gli accordi con spedizionieri s’intendono sempre conclusi in nome e per conto del Committente che fin d’ora ratifica ed accetta l’operato.
- 3) TERMINI DI CONSEGNA** - I termini di consegna hanno carattere indicativo, eventuali ritardi nelle consegne, interruzioni, sospensioni totali o parziali delle forniture non daranno diritto ad indennizzi o risarcimento danni.
- 4) CONTESTAZIONI** - La garanzia della merce è limitata al solo, ed esclusivamente, materiale di prima scelta, con una tolleranza del 5% circa. Le differenze di tonalità non potranno essere denunciate come vizio del materiale. Eventuali reclami in merito alla qualità, tipo del materiale, dovranno pervenirci entro 8 giorni dalla data di consegna. Il compratore s’impegna a tenere a disposizione le partite contestate così da consentire il controllo dei difetti denunciati, in ogni caso la posa in opera ci esonera da qualsiasi responsabilità. Eventuali vizi o difetti di qualità della merce, ove siano denunciati nei termini di legge ed accertati o riconosciuti, danno diritto solamente alla sostituzione dei materiali difettosi, a condizione della preventiva restituzione delle merci contestate, e, su autorizzazione scritta dell’operazione di resa, restando tassativamente esclusi la risoluzione del contratto e qualsiasi risarcimento danni.
- 5) DIMENSIONI E TONALITÀ** - I nostri materiali sono da classificarsi fra i prodotti cotti ad alta temperatura e come tali possono presentare differenze tra le dimensioni dichiarate e quelle effettivamente consegnate. Così si dica per le differenze di tono all’interno della medesima partita. Quanto sopra perciò non potrà essere oggetto di reclamo da parte del committente.
- 6) IMBALLO E QUANTITÀ** - Il buono stato degli imballi e della loro confezione nonchè della quantità consegnata resta accertato con l’accettazione della merce da parte del vettore. Questi, firmando la Bolla di Accompagnamento, si rende responsabile del buono stato del materiale e del quantitativo. Il compratore nel caso si verifichino rotture ed ammanchi dovrà chiedere eventuali danni o risarcimenti al vettore.
- 7) RESI** - Per nessuna ragione l’acquirente potrà restituire il materiale senza nostra espressa preventiva autorizzazione scritta e tutte le spese sono a carico del Committente.
- 8) ANNULLI** - Non verranno accettati annullamenti di ordini se il materiale è già stato prodotto o se è già stata avviata la lavorazione e molto più se è già stata effettuata la spedizione. L’annullamento dell’ordine comporterà in ogni caso l’obbligo da parte del Committente di pagare l’intera fornitura. Nel caso che sia fattibile l’accettazione dell’annullamento il Cliente sarà tassativamente tenuto a rifondere tutte le spese sostenute dal produttore fino a quel momento.
- 9) PREZZI** - I prezzi riportati sui nostri listini non sono per noi impegnativi. Ci riserviamo il diritto di modificarli prima dell’accettazione dell’ordine.
- 10) PAGAMENTI** - I pagamenti devono essere effettuati solo presso la nostra sede. Il ritardo di 10 giorni di ogni pagamento dovuto, o la mancata copertura nel termine stesso di un titolo di credito, girato o ceduto o emesso dal committente, costituisce grado di insolvenza. In tal caso sarà nostra facoltà sospendere le forniture ed annullare ogni rapporto in corso; immediatamente esigere l’integrale pagamento di ogni rapporto in corso; esigere l’integrale pagamento di ogni nostro credito ed agire giudizialmente al riguardo, in via esecutiva o cautelare nonchè per il risarcimento danni; in ogni caso, trascorsi 10 giorni da ogni pagamento dovuto, siamo autorizzati a emettere tratta a vista con spese senza preavviso. Inoltre decorreranno sul debito scaduto gli interessi moratori annui calcolati nella misura del tasso “prime rate” corrente maggiorato di 5 punti percentuali.
- 11) UNITÀ MINIMA DI VENDITA** - Non si effettuano vendite inferiori alla scatola.
- 12) RISERVATO DOMINIO** - Il materiale anche se spedito e regolarmente fatturato resta di nostra proprietà fino al pagamento totale della fornitura medesima anche in caso di passaggio o vendita terzi.
- 13) FORO COMPETENTE** - Per qualsiasi controversia sarà esclusivamente competente il foro di Modena.

Servizi di logistica

ANNULLAMENTO ORDINI - per l’annullamento autorizzato di ordini di materiali già consegnati al nostro deposito, e per resi autorizzati, verrà addebitato il 15% del valore imponibile, con fisso minimo di 50€, per contributo spese di trasporto e riselezione.

ORDINI DI PICCOLE QUANTITÀ - per ordini di fondi, gradini o battiscopa inferiori ai 5 colli complessivi verrà richiesto un contributo di spese di packaging e movimentazione pari a 20€.

SPALLETTIZZATO - per ordini di metratura inferiore al pallet completo, verrà applicata una maggiorazione pari a 1,80 €/m² e 3,00 €/m² per la serie X20.

CONSEGNE URGENTI - per preparazione di ordini entro le 24 ore, con un limite massimo di 2 articoli totali, verrà addebitata una maggiorazione di 30€ netta fissa.

Imballaggi

ADDEBITO - Gli imballaggi speciali saranno addebitati al costo visibile nella tabella riepilogativa.

RESO - Gli imballi dei formati 160x320 e 120x280 potranno essere resi e riaccreditati a condizione che vengano restituiti in buono stato. Nulla potrà essere riconosciuto per imballi non più riutilizzabili o di formati di dimensioni inferiori.

General sales terms and conditions

- 1) APPROVAL** - All orders that we receive are considered to be binding only after our written confirmation has been issued.
- 2) DELIVERY** - The materials are intended as delivered upon loading at our warehouses. All transport risks, including missing pieces, breakage, deterioration and tampering are the sole responsibility of the Client, even if the price agreed upon is carriage free, FOB, ar C&F. Agreements with forwarding agents are intended as concluded in the name of and on behalf of the Client, who hereby confirms and accepts their terms and conditions.
- 3) TERMS OF DELIVERY** - The terms of delivery are indicative, eventual delays in the delivery, interruptions, or total or partial suspensions of the supply do not allow any right to indemnification or compensation for damages.
- 4) DISPUTES** - The guarantee of the goods is limited only and exclusively to first rate materials, with a tolerance of approximately 5%. The difference in shades of colour cannot be declared as a material defect. Eventual complaints regarding the quality or the type of material must be submitted within 8 days from the date of delivery. The purchaser agrees to make available the disputed lots in order that the declared defects may be controlled. In any case, the installation exonerates the manufacturer from any liability. Eventual manufacturing defects or quality defects in the goods, where declared according to law and ascertained or recognized, give right only to the replacement of the defective materials, provided that the goods have been returned previously and the written authorization of the return operation has been issued, the resolution of the contract as well as any compensation for damages is peremptorily waived and excluded.
- 5) DIMENSIONS AND TONALITY** - Our materials are classified as products fired at high temperatures and as such may present discrepancies between the dimensions declared and those actually delivered. The same applies for differences in colours within the same production lot. Therefore, the client may not present a dispute regarding above mentioned product characteristic.
- 6) PACKAGING AND QUANTITY** - The good condition of the packaging and cartons as well as the quantity delivered are verified upon acceptance of the goods by the forwarding agent. The forwarding agent declares himself responsible for the condition and quality of the goods upon signing the packing list. In case of missing pieces of breakage, the purchaser must ask for eventual damages or compensation from the forwarding agent.
- 7) RETURNS** - For no reason will purchaser be able to return the material without our express prior written authorization and all the costs of the return will be assumed by the Client.
- 8) CANCELLATIONS** - Order cancellations will not accepted if the material has already been produced or if the production has already begun, and more so if the materials have already been shipped. In any case, the Client is obliged to pay the entire sum of the supply if the order is cancelled. If the acceptance of the cancellation is feasible, the Client will be peremptorily obliged to reimburse all the expenses sustained by the producer up to that moment.
- 9) PRICES** - The prices on our price list are not binding. We reserve the right to modify prices before accepting an order.
- 10) PAYMENT** - Payments must be made only in our main office. Delays of more than 10 days for each payment due or insufficient funds during rhe same term of a check, whether endorsed of transferred, or issued by the customer, constitutes bad debt. In this case, we reserve the right to suspend supply and annual all ongoing relations, immediately require total payment of all ongoing relations; require total payment of each credit and to make legal recourse, whether executive or precautionary, as well as request compensation for damages. In any case, after 10 days any payment due,we are authorized to issue an on-sight draft with expenses without notice. Furthermore, annual penalty interest will accumulate on the expired debt to be calculated according to the current “Prime rate” plus five (%) percentage points.
- 11) MINIMUM PACKAGING REQUIREMENTS** - Sales of less than one box will not be allowed.
- 12) SELLER’S LIEN** - The material, even is shipped and regularly invoiced, remains our property until payment in full of the invoice itself, even in case of passage or sale to third parties.
- 13) PLACE OF JURISDICTION** - For any eventual dispute, the only place of jurisdiction will be the Modena Tribunal.

Logistic services

ORDER CANCELLATION - for the authorized cancellation of orders for materials already delivered to our warehouse, and for authorized returns, 15% of the taxable value will be charged, with a fixed minimum of €50, for transport and reselection costs.

SMALL QUANTITY ORDERS - for orders of solid colour basic tiles, treads or skirting boards amounting to less than 5 total packages, a contribution to cover packaging and handling costs of €20 will be due.

ORDERS FOR LESS THAN 1 PALLET - for orders smaller than the full pallet, a surcharge of €1.80/m² and €3.00/m² for entire X20 series will be applied.

RUSHED DELIVERIES - for rushed orders (within 24 hours), with a maximum limit of 2 total items, a fixed net surcharge of €30 will be charged.

Packaging

CHARGE - Special packaging will be charged at the cost shown in the summary table.

RETURN - The packaging of the 160x320 and 120x280 sizes can be returned and re-credited providing that it is returned in good condition. No amount will be credited for packaging that is no longer reusable or smaller in size.

Index

Projects

Marble	Supreme Memories Supreme Treasure Supreme Evo Supreme Classic Navona
Stone	Double Rockin’ Blue Savoy Re_Tour Nordik Stone
Wood	Four Seasons Nordik Wood Cozy Flaviker-Dakota Zen
Metal	Rebel
Concrete	Hyper Backstage

Decor & Wall

	Art Walls Flow Chrome
--	-----------------------------

Outdoor

X20 - 20 mm	Supreme Memories Double Rockin’ Hyper Blue Savoy Still No_w Rebel Nordik Stone Re_Tour Navona Four Seasons Nordik Wood Cozy Flaviker-Dakota
X30 - 30 mm	Backstage Nordik Stone Rebel Navona Flaviker-Dakota

Technical Information

Conditions générales de vente

1) ACCEPTATION - Les commandes parvenues ne seront valables de manière définitive qu’après confirmation écrite de notre part.

2) LIVRAISON - La livraison du matériel est à considérer effectuée au moment du chargement dans nos entrepôts. Tous les risques de transport, tels que les manques, les casses ,détériorations ou endommagements sont à la charge de l’Acheteur, même lorsque le prix convenu est franco , FOB ou C&F. Les accords conclus avec les transporteurs sont à considérer toujours au nom et pour compte de l’Acheteur, qui confirme et accepte le conditions au préalable.

3) DÉLAIS DE LIVRAISON - Les délais de livraison ont un caractère indicatif; les éventuels retards de livraisons, interruptions, suspensions totales ou partielles des fournitures ne donneront droit à aucun dédommagement ou remboursement et intérêts.

4) RECLAMATIONS - La garantie de la marchandise se limite seulement et exclusivement au materiel de premier choix, avec une marge de tolérance de 5% environ. Les différences de nuances ne pourront être dénoncées comme vice du matériel. Les éventuelles réclamations relatives à la qualité, au type de matériel, devront nous parvenir dans les 8 jours à partir du jour de livraison. L’Acheteur s’engage à mettre à disposition les parties contestées de manière à permettre le contrôle des défauts déclarés, sachant que la pose nous libère quoiqu’il en soit de toute responsabilité. Les éventuels vices ou défauts de qualité de la marchandise, si déclarés en vertu des termes de loi et confirmés ou reconnus, ne donnent droit qu’a la substitution des matériaux défectueux, à condition que les marchandises contestées ne soient rendues préalablement et, sur autorisation écrite de l’opération de restitution, en renonçant et en excluant ainsi de manière formelle la résolution du contrat tout comme les éventuels dommages et intérêts.

5) DIMENSIONS ET NUANCES - Nos matériels se classent parmi les produits cuits à haute températures et peuvent présenter en tant que tels des différences entre les dimensions déclarées et celles effectivement livrées.

C'est ainsi que sont considérées les différences de nuance à l’intérieur d’un même lot. C’est pourquoi, en vertu des conditions présentées précédemment, ceci ne pourra faire l’objet d’aucune réclamation de la part de l’Acheteur.

6) EMBALLAGE ET QUANTITES - Le bon état des emballages, ainsi que de la quantité livrée est confirmé après acceptation de la marchandise de la part du transporteur. Ce dernier, en signant le Bon de Livraison, se tient responsable du bon état du matériel et de la quantité. En cas de casses ou manques, l’acheteur devra demander des éventuels dommages et intérêts ou dédommagements au transporteur.

7) RESTITUTIONS - En aucun cas l’Acheteur ne pourra rendre la matériel sans préalablement recevoir une autorisation écrite de notre part et tous les frais sont à la charge de l’Acheteur.

8) ANNULLATIONS - Aucune annulation de commandes ne sera acceptée si le matériel a déjà été produit ou si la phase de production a déjà été commencé, ni même si la livraison a déjà été effectuée. L’annulation de la commande comportera dans tous les cas l’obligation de la part de l’Acheteur de payer la totalité de la marchandise. Au cas ou l’acceptation de l’annulation est faisable, le Client sera formellement tenu à recouvrir tous les frais engendrés par le producteur jusqu’alors.

9) PRIX - Les prix reportés sur nos catalogues ne sont pas définitifs. Nous nous réservons le droit de les modifier avant l’acceptation de la commande.

10) PAIEMENTS - Les paiements ne doivent être effectués qu’auprès de notre siège. Le retard de plus de 10 jours de tout paiement dû ou la non couverture dans le même délai d’un titre de crédit, transféré ou cédé,ou bien émis par l’Acheteur, consitue un niveau d’insolvabilité. Dans ce cas, il est en notre pouvoir de suspendre les livraisons et annuler tout rapport en cours; d’exiger le paiement intégral et immédiat de nos crédits; d’exiger le paiement intégral de tout en notre faveur et d’agir judiciairement à cet égard, de manière exécutive ou préventive ainsi que pour les dommages et intérêts. Dans tous les cas, aussitôt qu’un paiement du dépasse le délai des 10 jours, nous sommes autorisés à émettre une traite à vue avec frais sans préavis. En outre, les intérêts moratoires annuels calculés en fonction du taux “premiers versements” courant majoré à 5 points pourcents, prendrant effet sur le débit dépassé.

11) MINIMUM UNITE DE VENTE - Aucune vente inférieure à la boîte ne peut être effectuée.

12) DOMAINE RÉSERVÉ - Le matériel, même si livré et régulièrement facturé reste notre propriété jusqu’au paiement total de ladite marchandise, même en cas de passage ou vente à un tiers.

13) TRIBUNAL COMPETENT - Le Tribunal de Modena sera compétent de manière exclusive en cas de litige.

Services de logistique

ANNULATION DES COMMANDES - pour l’annulation autorisée de commandes de matériaux déjà livrés à notre entrepôt, et pour les retours autorisés, 15 % de la valeur imposable seront facturés, avec une contribution minimale fixe de 50 € pour les frais de transport et de resélection.

COMMANDES DE PETITES QUANTITÉS - pour les commandes de fonds, marches ou plinthes inférieures à 5 colis au total, une contribution aux frais d’emballage et de manutention de 20 € sera exigée.

PRODUIT DÉPALETTISÉ - un supplément de 1,80 €/m² et de 3,00 €/m² pour toute la série X20 sera appliqué aux commandes inférieures à la palette complète.

LIVRAISONS URGENTES - pour la préparation des commandes dans les 24 heures, avec une limite maximale de 2 articles au total, un supplément fixe net de 30 € sera facturé.

Emballages

FACTURATION - les emballages spéciaux seront facturés au tarif indiqué dans le tableau récapitulatif.
RETOUR - les emballages des formats 160x320 et 120x280 pourront être retournés et crédités à nouveau à condition qu’ils soient en bon état.

Aucun remboursement ne sera accordé pour les emballages de plus petite taille ou pour ceux qui ne sont plus réutilisables.

Allgemeine verkaufsbedingungen

1) BESTÄTIGUNG - Eingegangene Bestellungen sind für uns nur verbindlich, wenn sie schriftlich durch uns bestätigt wurden.

2) LIEFERUNG - Die Lieferung des Materials ist für uns mit dessen Beladung bei unserem Lager abgeschlossen. Alle durch den Transport bedingten Risiken, einschließlich Fehlmengen, Bruch, Beschädigung und sonstige Beeinträchtigungen gehen zu Lasten des Auftraggebers, auch wenn der vereinbarte Preis frachtfrei. FOB oder C&F ist. Die Vereinbarungen mit den Speditionsunternehmen werden im Namen und auf Rechnung des Auftraggebers getroffen, der die Entlastung bestätigt und erteilt.

3) LIEFERFRISTEN - Die Lieferfristen sind ungefähre Angaben; im Falle einer Verzögerung, Unterbrechung bzw. teilweiser oder kompletter Aussetzung der Lieferungen besteht kein Recht auf Entschädigung oder Schadenerstatz.

4) BEANSTANDUNGEN - Die Garantie auf die Ware bezieht sich ausschließlich auf Material erster Wahl, bei einer Toleranz von ca. 5%. Unterschiede bei Farbtönen können nicht als Materialfehler geltend gemacht werden. Eventuelle Beanstandungen in Bezug auf die Qualität und vzw müssen innerhalb von 8 Tagen ab dem Lieferdatum bei uns eingehen. Der Käufer verpflichtet sich, die beanstandeten Warenpartien für die Überprüfung der angezeigten Mängel zur Verfügung zu halten. Die Verlegung des Materials befreit uns in jedem Fall von jeglicher Haftung. Eventuelle Fehler oder Qualitätsmängel der Ware, sofern diese innerhalb der gesetzlich vorgeschriebenen Fristen gemeldet, überprüft und anerkannt wurden, beinhalten lediglich das Recht auf einen Umtausch der fehlerhaften Materialien, unter der Bedingung, dass die beanstandete Ware vorher, nach schriftlicher Genehmigung der Warenrückgabe, zurückgeschickt wurde und unter Verzicht und Ausschluss des Anspruchs auf eine Vertragsauflösung oder jegliche Art von Schadenersatz.

5) ABMESSUNGEN UND FARBTÖNE - Unsere Materialien sind als Produkte klassifiziert, die bei hohen Temperaturen gebrant werden, weshalb es sein kann, dass die tatsächlichen Abmessungen von den genannten Abmessungen abweichen. Das gleiche gilt für Farbunterschiede innerhalb desselben Warenpostens. Diese Umstände geben dem Auftraggeber kein Recht zu Beanstandungen.

6) VERPACKUNG UND MENGE - Mit Annahme der Ware durch das Beförderungsunternehmen gelten der gute Zustand der Verpackungen sowie die übergebene Warenmenge als bestätigt. Das Transportunternehmen übernimmt mit Unterzeichnung des Versandscheins die Verantwortung für den guten Zustand und die Menge des Materials. Der Käufer muss sich im Fall von Brüchen oder Fehlware für eventuelle Schäden oder Entschädigungen as das Beförderungsunternehmen wenden.

7) WARENRÜCKGABE - Der Käufer kann die Ware in keinem Fall ohne unsere ausdrückliche schriftliche Genehmigung zurückgeben; alle entstehenden Kosten werden vom Auftraggeber übernommen.

8) STORNIERUNGEN - Auftragsstornierungen werden nicht akzeptiert, wenn das Material bereits hergestellt wurde, die Produktion angelaufen ist oder die Ware gar bereits verschickt wurde. Bei der Stornierung einer Bestellung ist der Auftraggeber in jedem Fall verpflichtet, die gesamte Lieferung zu bezahlen. Falls die Stornierung akzeptiert wird, ist der Kunde verpflichtet, alle Kosten zu übernehmen, die dem Hersteller bis zu diesem Zeitpunkt entstanden sind.

9) PREISE - Die in unserer Preisliste angegebenen Preise sind für uns nicht verbindlich. Wir behalten uns das Recht vor, diese vor de Bestellungsannahme zu ändern.

10) ZAHLUNG - Die Zahlungen können nur direkt an uns erfolgen. Eine Verspätung von mehr als 10 tagen jeder geschuldeten Zahlung bzw. die fehlende Deckung eines girierten, abgetretenen oder vom Auftraggeber ausgestellten Kreditpapiers innerhalb desselben Zeitraums wird als Zahlunsunfähigkeit gewertet. In diesem Fall haben wir das Recht, die Lieferungen auszusetzen und jedes bestehende Geschäftsverhältnis abzubrechen; unverzüglich die vollständige Zahlung aller unserer Forderungen im Rahmen eines Vollstreckungs- oder Sicherstellungsverfahrens rechtlich zu beanspruchen, ebenso wie eine Entschädigung; in jedem fall sind wir 10 Tage nach Ablauf der Zahlungsfrist berechtigt, ohne Vorankündigung eine Sichtratte zuzüglich der entsprechenden Kosten auszustellen. Außerdem werden auf den geschuldeten Betrag die jährlichen Verzugszinsen in Höhe des laufenden, um fünf Prozentpunkte erhöhten Privatdiskontsatzes berechnet.

11) VERPACKUNGSGRÖSSE - Es werden keine Mengen unterhalb der Größe eines Kartons verkauft.

12) EIGENTUMSVORBEHALT - Das Material bleibt auch bei regulärem Transport und normaler Rechnungsstellung bis zur vollständigen Bezahlung der Lieferung in unserem Eigentum, auch im Falle der Weitergabe oder des Verkaufs an Dritte.

13) GERICHTSSTAND - Gerichtsstand in Streitfällen ist ausschießlich das Gericht Modena.

Logistik-dienstleistungen

STORNIERUNG VON BESTELLUNGEN - Für die genehmigte Stornierung von Bestellungen von Waren, die bereits an unser Lager geliefert wurden, und für genehmigte Rücksendungen werden 15 % des steuerpflichtigen Wertes mit einem festen Mindestbetrag von 50 € als Unkostenbeitrag für Transport und Neuauswahl berechnet.

BESTELLUNG KLEINER MENGEN - Bei Bestellungen von Grundfliesen, Stufen oder Sockelleisten unter 5 Packstücken wird ein Unkostenbeitrag für Verpackung und Beförderung von 20 € erhoben.

ENTPALLETIERT - Bei Bestellmengen von weniger als einer ganzen Palette wird ein Zuschlag von 1,80 €/m² und 3,00 €/m² für die ganze Serie X20 berechnet.

EILLIEFERUNGEN - Für die Bearbeitung von Bestellungen innerhalb von 24 Stunden und maximal 2 Artikel wird ein pauschaler Aufschlag von 30 € netto berechnet.

Verpackungen

VERPACKUNGSGEBÜHR - Die Kosten für Sonderverpackungen werden gemäß der zusammenfassenden Tabelle berechnet.

RÜCKGABE VON VERPACKUNGEN - Eine Rückgabe und Gutschrift von Verpackungen der Formate 160x320 und 120x280 ist möglich, sofern sie in einem guten Zustand sind. Für Verpackungen, die nicht wiederverwendbar oder auf kleinere Formate rückführbar sind, wird nichts anerkannt.

Index

Projects

Marble	Supreme Memories <p>Supreme Treasure</p> Supreme Evo <p>Supreme Classic</p> Navona
Stone	Double <p>Rockin’</p> Blue Savoy <p>Re_Tour</p> Nordik Stone
Wood	Four Seasons <p>Nordik Wood</p> Cozy <p>Flaviker-Dakota</p> Zen
Metal	Rebel
Concrete	Hyper <p>Backstage</p>

Decor & Wall

Art Walls <p>Flow</p> Chrome

Outdoor

X20 - 20 mm	Supreme Memories <p>Double</p> Rockin’ <p>Hyper</p> Blue Savoy <p>Still No_w</p> Rebel <p>Nordik Stone</p> Re_Tour <p>Navona</p> Four Seasons <p>Nordik Wood</p> Cozy <p>Flaviker-Dakota</p>
X30 - 30 mm	Backstage <p>Nordik Stone</p> Rebel <p>Navona</p> Flaviker-Dakota

Technical Information

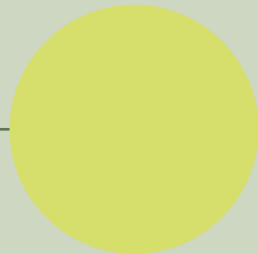

ОБЩИЕ УСЛОВИЯ ПРОДАЖИ

- 1 ПОДТВЕРЖДЕНИЕ** - Поступившие к нам заказы действительны только после нашего письменного подтверждения.
- 2 ПОСТАВКА** - Поставка материала считается выполненной в момент окончания погрузки на наших складах. Заказчик несет все риски, связанные с транспортировкой, включая недостачу, поломку, порчу и нарушение целостности упаковки, также если на продукцию установлена цена франко-порт, FOB или C&F. Соглашения с экспедиторами всегда заключаются от имени и за счет Заказчика, который с момента заключения соглашения утверждает и принимает прделанную работу.
- 3 СРОКИ ПОСТАВКИ** - Сроки поставки имеют ориентировочный характер, возможная задержка поставки, ее приостановка, частичное или полное прекращение не дают права на возмещение убытков или компенсацию за ущерб.
- 4 ПРЕДЪЯВЛЕНИЕ ПРЕТЕНЗИЙ** - Гарантия на товар распространяется только и исключительно на первосортный материал с допусаемым отклонением приблизительно на 5%. Различия в оттенках не будут считаться дефектом материала. Возможные претензии в отношении качества, типа материала должны быть предъявлены в течение 8 дней с даты поставки. Покупатель обязуется предоставить признанные им дефектными партии товара для проверки обоснованности претензии; в любом случае, после укладки материала мы не несем никакой ответственности. Возможные выявленные или подтвержденные недостатки или дефекты качества товара, при условии, что покупатель заявил о них в течение установленных законом сроков, дают покупателю право только на замену дефектного материала, которая осуществляется после возврата дефектного товара и на основании акта о возврате товара, составленного в письменной форме, при этом категорически исключается отказ от договора или его расторжение, а также какое-либо возмещение убытков.

5 РАЗМЕРЫ И ОТТЕНКИ - Наши материалы относятся к продуктам, которые подвергаются обжигу при высокой температуре, поэтому заявленные и реальные размеры поставленных изделий могут отличаться. Это касается и различий в оттенках изделия из одной и той же партии. В связи с этим размеры и оттенки не могут быть предметом рекламации со стороны заказчика.

6 УПАКОВКА И КОЛИЧЕСТВО - Перевозчик должен проконтролировать груз по количеству и целостности упаковки при приемке товара. Перевозчик, подписывая Сопроводительную Накладную, несет ответственность за сохранность материала и за его количество. В случае обнаружения повреждений и недостачи возможные претензии о возмещении ущерба за понесенные убытки покупатель должен предъявлять перевозчику.

7 ВОЗВРАТ ТОВАРА - Покупатель не может ни на каком основании осуществлять возврат товара без нашего предварительного письменного согласия. Все расходы будут отнесены на счет Заказчика.

8 АНУЛИРОВАНИЕ ЗАКАЗА - Отмена заказа не будет приниматься, если материал был уже изготовлен, или если уже было начато его производство, а тем более, если уже была произведена отправка. В любом случае, при отмене заказа Заказчик будет обязан произвести оплату всей поставки. Если отмена заказа будет возможна, Клиент должен будет возместить все расходы, понесенные производителем до момента отмены.

9 ЦЕНЫ - Цены, указанные в наших прайс-листах, имеют ориентировочный характер. Мы оставляем за собой право изменить цены перед принятием заказа

10 ПЛАТЕЖИ - Оплата товара должна производиться только прямым платежом. Задержка более чем на 10 дней каждого причитающегося платежа или отсутствие покрытия в срок векселя, который был передан, уступлен или выставлен заказчиком, является состоянием неплатежеспособности. В таком случае мы оставляем за собой право приостановить поставку, отменить все текущие отношения, а также немедленно потребовать полной выплаты каждой задолженности и обращаться по этому поводу в суд, в исполнительном или предупредительном порядке, а также с требованием возмещения ущерба; в любом случае, по истечении 10 дней с даты причитающегося платежа, мы имеем право без предупреждения выписать переводный вексель на предъявителя с оплатой издержек. Кроме того, на просроченную задолженность начисляются проценты по неустойке по текущей процентной ставке 5 % годовых.

11 РАСПАКОВКА КОРБОК - Продажа товара осуществляется только целыми заводскими коробками.

12 ПРАВО УДЕРЖАНИЯ ТОВАРА - товар остается нашей собственностью до момента полной оплаты поставки даже в случае, если была произведена отправка, и был выставлен счет-фактура также в случае передачи или продажи товара третьим лицам.

13 КОМПЕТЕНТНЫЙ СУД - Рассмотрение любых споров будет находиться в исключительной компетенции Суда г. Модены.

УСЛУГИ ЛОГИСТИКИ

ОТМЕНА ЗАКАЗОВ – за разрешенную отмену заказов на материалы, уже поставленные на наш склад, а также за разрешенный возврат, будет взиматься сумма в размере 15% от налогооблагаемой базы с минимальным фиксированным размером в 50€ в счет возмещения транспортных расходов и пересортировки.

ЗАКАЗЫ НА МАЛЫЕ КОЛИЧЕСТВА – за заказы на фоновую плитку, ступени или плитусы в общем количестве менее 5 упаковок будет взиматься плата за упаковку и перемещение на сумму 20€.

НЕПОЛНЫЙ ПОДДОН – за заказы, метраж которых меньше одного полного поддона, будет взиматься наценка в размере 1,80€/м² и 3,00€/м² за серию X20.

СРОЧНЫЕ ПОСТАВКИ – за подготовку заказов в течение 24 часов, максимум на 2 артикула, будет взиматься чистая фиксированная наценка в размере 30€.

УПАКОВКА

ПЛАТА ЗА УПАКОВКУ – За специальную упаковку будет взиматься плата, указанная в сводной таблице.

ВОЗВРАТ УПАКОВКИ – Упаковка для форматов 160x320 и 120x280 может быть возвращена и взаимозачтена, если она возвращается в хорошем состоянии.

Не возмещается плата за упаковку, находящуюся в непригодном состоянии или же для форматов меньших размеров.

Imballi packaging

NUOVI SISTEMI DI IMBALLO

L'innovazione del progetto lastre si esprime anche attraverso la parte logistica del progetto. ABK Group rivoluziona il sistema di imballaggio delle lastre ed è a oggi l'unica azienda che ha portato il sistema a cavalletto impilabile alla dimensione di cm 75x284x147,5 (lastre 120x280) 75x168x109 (lastre 80x160) e 75x26x200 (lastre 26x200).

Questi i principali vantaggi offerti:

-essendo impilabile permette di ottimizzare gli spazi all'interno dei magazzini.*

- la profondità di 75 cm consente di sfruttare a pieno il volume di carico dei container (3 pallets ne occupano perfettamente la larghezza).

- Il posizionamento verticale del prodotto garantisce una maggiore protezione delle lastre durante le fasi di trasporto.

- facilita le operazioni sul cantiere in quanto le lastre si trovano già posizionate in verticale, il materiale è facilmente ispezionabile e removibile per l'installazione.

- le dimensioni complessive del cavalletto consentono maggiori spazi di manovra all'interno dei locali di posa rispetto alle casse tradizionali e agevolano il sollevamento del materiale mediante mezzi meccanici (gru-montacarichi).

-è caratterizzato da un sistema di regettatura che consente di liberare anche 1 solo collo alla volta, senza compromettere la stabilità del materiale che rimane sul pallet, evitando così il rischio di rotture. Le lastre dovranno essere liberate rispettando la sequenza opposta rispetto a quella con cui sono state confezionate, quindi iniziando dall'ultimo collo regettato.

Cavalletto impilabile

Stackable rack pallet

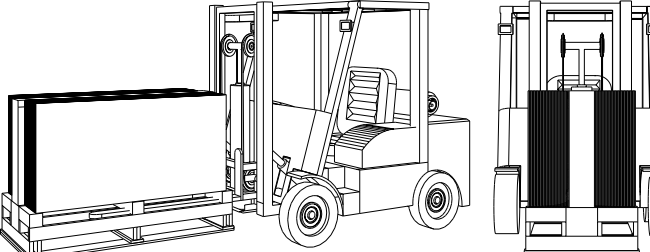
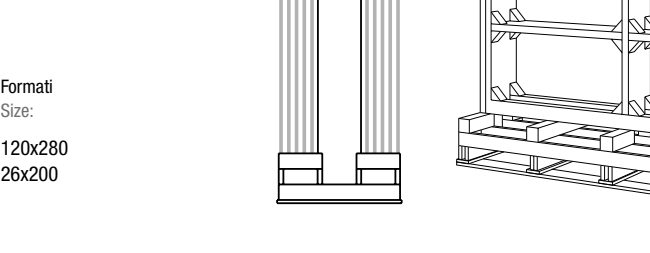

Carico su camion

Truck loading

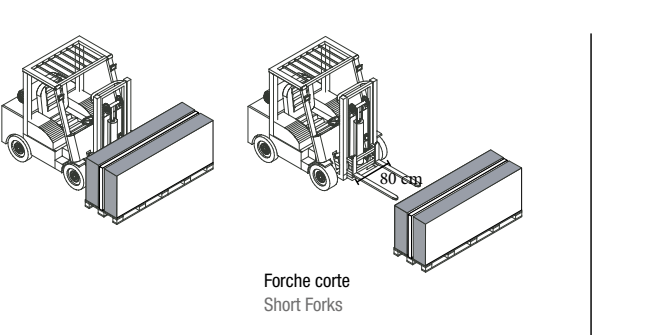

NEW PACKAGING SYSTEMS

Innovation in the slab's range is also reflected in the project's logistics. ABK Group has revolutionised the packaging of ceramic slabs and is the only company to have expanded the stacking rack pallet system to the 75x284x147,5 (slabs 120x280) 75x168x109 (80x160 slabs) and 75x26x200 (slabs 26x200) cm size.

This has the following advantages:

- stacking optimises the use of space in warehouses.*

- the 75 cm depth enables full use of container load space (3 pallets fit perfectly side by side). The vertical positioning of the product better protects the slabs during shipping.

- it facilitates work on site, since the slabs are already positioned vertically, making the material easy to inspect and remove for installation.

- the overall size of the rack pallet provides greater space for manoeuvring in the installation area in comparison with conventional crates, and also makes it easier to lift the slabs mechanically (with a crane or lift).

- the rack pallet system employs strapping which allows the user to remove a single package at a time without affecting the stability of the other packages on the pallet, thus minimising the risk of breakage. The slabs must be released from the packaging by reversing the packaging sequence, i.e. starting with the last package to have been strapped on.

Carico su container

Container loading

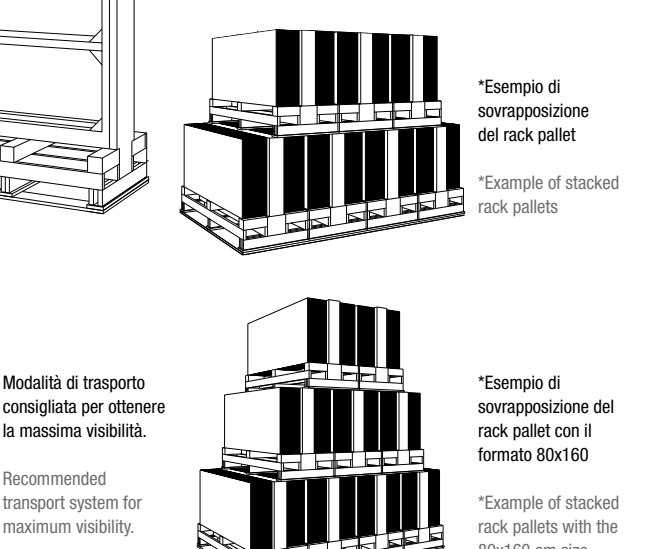

Projects

Marble	Supreme Memories Supreme Treasure Supreme Evo Supreme Classic Navona
Stone	Double Rockin' Blue Savoy Re_Tour Nordik Stone
Wood	Four Seasons Nordik Wood Cozy Flaviker-Dakota Zen
Metal	Rebel
Concrete	Hyper Backstage

Decor & Wall

Art Walls Flow Chrome

Outdoor

X20 - 20 mm	Supreme Memories Double Rockin' Hyper Blue Savoy Still No_w Rebel Nordik Stone Re_Tour Navona Four Seasons Nordik Wood Cozy Flaviker-Dakota
X30 - 30 mm	Backstage Nordik Stone Rebel Navona Flaviker-Dakota

Technical Information

Imballi packaging

Cassa

Crate

Impilabile
Stackable

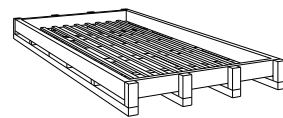

Ingombro Size 174x345x27,5
(160x320 RETT/LUX)
€ 220,00

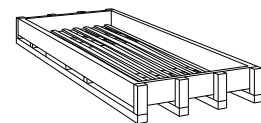

Ingombro Size 144x291x34
(120x280 LUX)
€ 150,00

Imballi per ordini al venduto

Picking order packaging

Formati

Size:

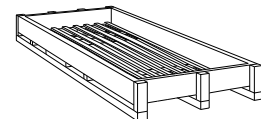

Ingombro Size 144x291x24
(120x280)
€ 90,00

quantità massima 5 lastre
maximum quantity 5 slabs

Materia imballi

Packaging 12/20 mm

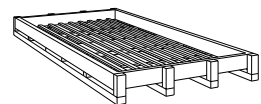

Cassa

Crate

Impilabile
Stackable

Ingombro Size 174x345x27,5
(160x320 RETT/LUX)
€ 220,00

Cavalletto

Rack pallet

Impilabile
Stackable

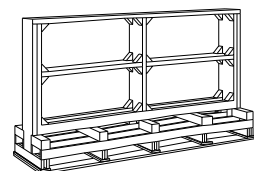

Ingombro Size 75x284x147,5
(120x280 RETT)
€ 220,00

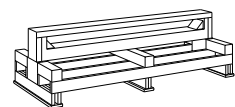

Ingombro Size 75x50x200
(26x200 RETT)
€ 68,00

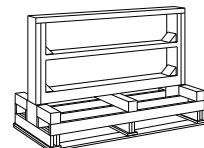

Ingombro Size 75x168x109
(80x160 RETT)
€ 120,00

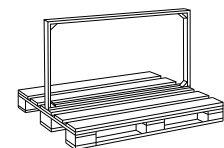

Ingombro Size 80x130x60
(60x120 30x120 80x80)
VERTICALE/VERTICAL
€ 90,00

Su richiesta imballo standard con scatole orizzontali senza addebito.
Standard packaging with laying boxes possible without charges.

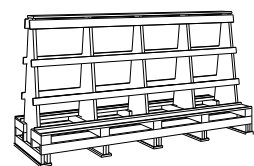

Cavalletto container legno A - frame

Container Rack pallet wood A - frame

Ingombro Size 75x330x201
(163,5x323)
€ 335,00

Cavalletto per containers

Rack pallet for containers

Non Impilabile
Not Stackable

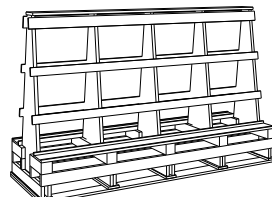

Ingombro Size 75x330x201
(160x320 RETT/LUX)
€ 335,00

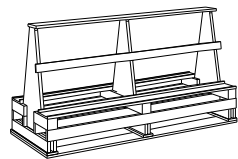

Ingombro Size 75x288x161
(120x280 RETT/LUX)
€ 295,00



Ingombro Size 75x130x149
(120x120 RETT/LUX)
€ 45,00

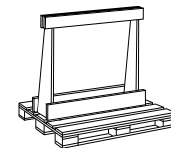

Ingombro Size 80x130x120
(120x120) VERTICALE/VERTICAL
€ 45,00

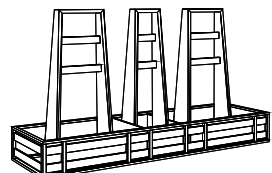

Cavalletto container metallo A - frame

Container Rack pallet metal A - frame

Ingombro Size 75x330x201
(163,5x323)
€ 515,00

Pallet con sponde

Pallet with sides

Impilabile
Stackable

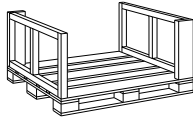

Ingombro Size 122x143x70
(120x120)
€ 45,00

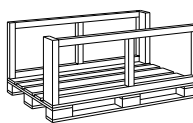

Ingombro Size 99x162x70
(80x160)
€ 70,00

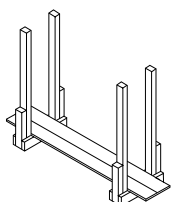

Legaccio

Bundle

Impilabile
Stackable

Ingombro Size 54x330x223

€ 240,00 6 mm
€ 210,00 12 mm
€ 240,00 20 mm

Imballi packaging

gres porcellanato / porcelain tiles

F.to nominale Nominal size	Finitura Finish	▼ ▲	F.to reale (mm) Work size	Imballo Packing	Pz/Scat. Pcs/Box	Mq/Scat. Sqm/Box	Kg/Scat. Kg/Box	Scat./Imb. Box/Packing	Pz Totali Pcs Total	Mq Totali Sqm Total	Kg/Imballo Kg/Packing	Kg Totali Kg Total	Prezzo Imb. Packing Price	Dimensioni Imballo Packing sizes
160x320 63"x126"	RETT.	6	1596,5x3195	Cassa Crate	-	-	-	-	15	76,80	139	1.294	€ 220,00	P. 174 L. 345 H. 27,5
				Cavalletto container Container rack pallet	-	-	-	-	36	184,32	180	2.952	€ 335,00	P. 75 L. 330 H. 201
120x280 48"x112"	RETT.	6	1194x2800	Cassa Crate	-	-	-	-	20	67,20	95	1.104	€ 150,00	P. 144 L. 291 H. 34
				Cavalletto Rack pallet	-	-	-	-	36	121	120	1.935	€ 220,00	P. 75 L. 284 H. 147,5
				Cavalletto container Container rack pallet	-	-	-	-	36	121	140	1.955	€ 295,00	P. 75 L. 288 H. 161
26x200 10"x78"	RETT.	6	264,4x2000	Cavalletto Rack pallet	5	2,60	39,00	18	90	46,80	50	752	€ 68,00	P. 75 L. 50 H. 207
40x170 16"x68"	RETT.	8,5	400x1700	Pallet	2	1,36	27,20	32	64	43,52	20	890	-	
20x170 8"x68"	RETT.	8,5	199x1700	Pallet	4	1,36	27,20	36	144	48,96	20	999	-	
80x160 32"x64"	RETT.	8,5	797,25x1596,5	Cavalletto Rack pallet	2	2,56	51,20	22	44	56,32	70	1196	€ 120,00	P. 75 L. 168 H. 109
80x160 32"x64"	RETT.	8,5	797,25x1596,5	Pallet con sponde Pallet with sides	2	2,56	51,20	22	44	56,32	40	1166	€ 70,00	P. 99 L. 162 H. 70
120x120 48"x48"	RETT.	8,5	1194x1194	Pallet con sponde Pallet with sides	2	2,88	57,60	18	36	51,84	40	1.077	€ 45,00	P. 122 L. 143 H. 70
120x120 48"x48"	RETT.	20	1194x1194	Pallet con sponde Pallet with sides	1	1,44	69,12	18	18	25,92	40	1.284	€ 45,00	P. 122 L. 143 H. 70
60x120 24"x48"	RETT.	6	596x1194	Pallet	3	2,16	32,40	27	81	58,32	20	895	-	
60x120 24"x48"	RETT.	8,5	596x1194	Pallet	2	1,44	28,80	30	60	43,20	20	884	-	
60x120 24"x48"	RETT.	8,5	-	Pallet	2	1,44	28,80	24	48	34,56	20	711	-	
60x120 24"x48"	RETT.	20	596x1194	Pallet	1	0,72	32,80	30	30	21,60	20	1.004	-	
40x120 16"x48"	RETT.	6	396,62x1194	Pallet	4	1,92	28,00	24	96	46,08	20	692	-	
30x180 12"x72"	RETT.	20	300x1800	Pallet	1	0,54	26,00	48	48	25,92	20	1.268	-	
30x120 12"x48"	RETT.	8,5	297x1194	Pallet	4	1,44	28,80	36	144	51,84	20	1.057	-	
30x120 12"x48"	RETT.	20	297x1194	Pallet	2	0,72	32,80	30	60	21,60	20	1.004	-	
30x120 12"x48"	RETT.	30	300x1200	Pallet	1	0,36	25,20	44	44	15,84	20	1.129	-	
20x120 8"x48"	RETT.	8,5	199x1194	Pallet	6	1,44	27,20	36	216	51,84	20	999	-	
5x120 2"x48"	RETT.	8,5	48x1194	Pallet	6	0,36	7,20	63	378	22,68	20	474	-	
90x90 36"x36"	RETT.	8,5	895x895	Pallet	2	1,62	32,40	22	44	35,64	20	733	-	
90x90 36"x36"	RETT.	20	896x896	Pallet	1	0,81	36,50	30	30	24,30	20	1.115	-	
90x90 36"x36"	RETT.	30	900x900	Pallet	1	0,81	56,70	20	20	16,20	20	1.154	-	
80x80 32"x32"	RETT.	8,5	797,25x797,25	Pallet	2	1,28	25,60	48	96	61,44	20	1.249	-	
60x90 24"x36"	RETT.	8,5	596x895	Pallet	1 CP	1,08	21,60	22	22 CP	23,76	20	495	-	
60x90 24"x36"	RETT.	20	596x895	Pallet	1	0,54	25,00	40	40	21,60	20	1.020	-	

Index



Projects

Material	Projects
Marble	Supreme Memories
	Supreme Treasure
	Supreme Evo
	Supreme Classic Navona
Stone	Double
	Rockin'
	Blue Savoy
	Re_Tour Nordik Stone
Wood	Four Seasons
	Nordik Wood
	Cozy
	Flaviker-Dakota Zen
Metal	Rebel
Concrete	Hyper Backstage

Decor & Wall

	Art Walls Flow Chrome
--	-----------------------------

Outdoor

X20 - 20 mm	X30 - 30 mm
Supreme Memories	Backstage
Double	Nordik Stone
Rockin'	Rebel
Hyper	Navona
Blue Savoy	Flaviker-Dakota
Still No_w	
Rebel	
Nordik Stone	
Re_Tour	
Navona	
Four Seasons	
Nordik Wood	
Cozy	
Flaviker-Dakota	

Technical Information



Imballi packaging

gres porcellanato / porcelain tiles

F.to nominale Nominal size	Finitura Finish	▼ ▲	F.to reale (mm) Work size	Imballo Packing	Pz/Scat. Pcs/Box	Mq/Scat. Sqm/Box	Kg/Scat. Kg/Box	Scat./Imb. Box/Packing	Pz Totali Pcs Total	Mq Totali Sqm Total	Kg/Imballo Kg/Packing	Kg Totali Kg Total	Prezzo Imb. Packing Price	Dimensioni Imballo Packaging sizes
40x80 16"x32"	RETT.	8,5	397,62x797,25	Pallet	3	0,96	19,20	30	90	28,80	20	596	-	
20x80 8"x32"	RETT.	8,5	199x800	Pallet	8	1,28	25,60	42	336	53,76	20	1.095	-	
60x60 24"x24"	RETT.	8,5	596x596	Pallet	3	1,08	21,60	40	120	43,20	20	884	-	
60x60 24"x24"	RETT.	20	596x596	Pallet	2	0,72	32,80	30	60	21,60	20	1.004	-	
60x60 24"x24"	RETT.	30	600x600	Pallet	1	0,36	25,20	44	44	15,84	20	1.129	-	
30x60 12"x24"	RETT.	8,5	297x596	Pallet	6	1,08	21,60	40	240	43,20	20	884	-	
30x60 12"x24" mix sizes	RETT.	8,5	-	Pallet	6	1,08	21,60	40	240	43,20	20	884	-	
10x60 4"x24"	RETT.	8,5	97,6x596	Pallet	12	0,72	14,50	50	600	36,00	20	745	-	
20x40 8"x16"	NAT.	8,5	-	Pallet	13	1,07	21,40	72	936	77,04	20	1.561	-	
7,5x40,7 3"x16"	NAT.	8,5	-	Pallet	28	0,88	16,00	42	1.176	36,96	20	692	-	

pasta bianca da rivestimento / white body wall tiles

F.to nominale Nominal size	Finitura Finish	▼ ▲	F.to reale (mm) Work size	Imballo Packing	Pz/Scat. Pcs/Box	Mq/Scat. Sqm/Box	Kg/Scat. Kg/Box	Scat./Imb. Box/Packing	Pz Totali Pcs Total	Mq Totali Sqm Total	Kg/Imballo Kg/Packing	Kg Totali Kg Total	Prezzo Imb. Packing Price	Dimensioni Imballo Packaging sizes
40x120 16"x48"	RETT.	6	400x1194	Pallet	4	1,92	23,00	24	96	46,08	20	572	-	
40x120 16"x48"	STRUTT. RETT.	6	400x1194	Pallet	3	1,44	19,00	24	72	34,56	20	476	-	
6x25 2"x10"	SATIN GLOSSY	8,5	-	Pallet	25	0,385	6,00	96	2.400	36,96	20	596	-	

I dati riferiti ai contenuti per scatole ed ai pesi degli imballi sono aggiornate al momento della stampa del catalogo. The data referred to the content per box and to the packing weight are update at the catalogue printing time.

Imballi packaging

MATERIA.

F.to nominale Nominal size	Finitura Finish	▼ ▲	F.to reale (mm) Work size	Imballo Packing	Lastre/ Imballo	Mq Totali Sqm Total	Kg/lastra Kg/slab	Kg/Imballo Kg/Packing	Kg Totali Kg Total	Prezzo Imb. Packing Price
163,5x323 64.67"x127.1"	NAT./SOFT/LUX	20	1635x3230	Cassa Crate	5	25,60	246	139	1.369	€ 220,00
		20	1635x3230	Cavalletto container legno A - frame Container Rack pallet wood A - frame	12 *10	61,44 51,20	246	180	3.132 2.640	€ 335,00
		20	1635x3230	Cavalletto container metallo A - frame Container Rack pallet metal A - frame	12 *10	61,44 51,20	246	180	3.132 2.640	€ 515,00
		20	1635x3230	Legaccio Bundle	12	61,44	246	60	3.012	€ 240,00
163,5x323 64.67"x127.1"	NAT./SOFT	12	1635x3230	Cassa Crate	9	46,08	149	139	1.480	€ 220,00
163,5x323 64.67"x127.1"	LUX	12	1635x3230	Cassa Crate	8	40,96	149	139	1.331	€ 220,00
163,5x323 64.67"x127.1"	NAT./SOFT/LUX	12	1635x3230	Cavalletto container legno A - frame Container Rack pallet wood A - frame	22 *18	112,64 92,16	149	180	3.458 2.862	€ 335,00
163,5x323 64.67"x127.1"	NAT./SOFT/LUX	12	1635x3230	Cavalletto container metallo A - frame Container Rack pallet metal A - frame	22 *18	112,64 92,16	149	180	3.458 2.862	€ 515,00
		12	1635x3230	Legaccio Bundle	18	92,16	149	60	2.742	€ 210,00
163,5x323 64.67"x127.1"	NAT./SOFT/LUX	6	1635x3230	Cassa Crate	15	76,80	77	139	1.294	€ 220,00
		6	1635x3230	Cavalletto container legno A - frame Container Rack pallet wood A - frame	36	184,32	77	180	2.952	€ 335,00
		6	1635x3230	Cavalletto container metallo A - frame Container Rack pallet metal A - frame	36	184,32	77	180	2.952	€ 515,00
		6	1635x3230	Legaccio Bundle	27	138,24	77	60	2.139	€ 240,00

* I cavalletti per carico su container prevedono 18 lastre in 12 mm anzichè 22 e 10 lastre in 20 mm anzichè 12.

* A Frame for container loading contains 18 slabs in 12 mm thickness and not 22, 10 slabs in 20 mm thickness and not 12.

FLAVIKER garantisce una superficie utile pari a 1635x3230 mm, la fatturazione invece è calcolata sulla base del formato 1600x3200 mm Su richiesta, le lastre in 6 e 20 mm di FLAVIKER possono essere rinforzate strutturalmente con una stuoia in fibra di vetro applicata sul retro con apposito collante, come avviene già in automatico per le lastre in 12mm.

L'applicazione della stuoia prevede una maggiorazione di € 10,00 al mq sul prezzo netto della lastra.

Su richiesta, le lastre possono essere rettificata nella dimensione di 1596,5x3195 mm con una maggiorazione sul prezzo.

FLAVIKER guarantees a useful surface area of 1635x3230 mm whereas billing is calculated on the basis of a 1600x3200 mm size.

On request, the 6 and 20 mm slabs from FLAVIKER can be reinforced with fiberglass matting applied to the rear surface using a special adhesive, as already happens automatically for 12 mm slabs. The fiberglass matting application involves a 10,00 € per sqm increase on the slab's net price. On request, slabs can be reticified size 1596,5x3195 mm with a price increase.

Le caratteristiche di superficie e le tonalità dei prodotti ceramici illustrati in questo catalogo sono da ritenersi puramente indicative. Optical features and color shades of ceramic materials illustrated in this catalogue are to be regarded as mere indications.



Ceramics of Italy

Projects

Marble	Supreme Memories Supreme Treasure Supreme Evo Supreme Classic Navona
Stone	Double Rockin' Blue Savoy Re_Tour Nordik Stone
Wood	Four Seasons Nordik Wood Cozy Flaviker-Dakota Zen
Metal	Rebel
Concrete	Hyper Backstage

Decor & Wall

	Art Walls Flow Chrome
--	-----------------------------

Outdoor

X20 - 20 mm	Supreme Memories Double Rockin' Hyper Blue Savoy Still No_w Rebel Nordik Stone Re_Tour Navona Four Seasons Nordik Wood Cozy Flaviker-Dakota
X30 - 30 mm	Backstage Nordik Stone Rebel Navona Flaviker-Dakota

Technical Information

Index

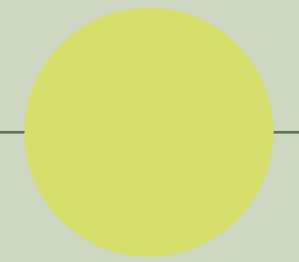

Projects

Marble	Supreme Memories Supreme Treasure Supreme Evo Supreme Classic Navona
Stone	Double Rockin' Blue Savoy Re_Tour Nordik Stone
Wood	Four Seasons Nordik Wood Cozy Flaviker-Dakota Zen
Metal	Rebel
Concrete	Hyper Backstage

Decor & Wall

	Art Walls Flow Chrome
--	-----------------------------

Outdoor

X20 - 20 mm	Supreme Memories Double Rockin' Hyper Blue Savoy Still No_w Rebel Nordik Stone Re_Tour Navona Four Seasons Nordik Wood Cozy Flaviker-Dakota
X30 - 30 mm	Backstage Nordik Stone Rebel Navona Flaviker-Dakota

Technical Information

FLAVIKER

WE
ARE **ABK**
GROUP